

Drag Racing
Analyzer v3.4 B
for Windows

User's Manual

Performance Trends, Inc.

Performance Trends, Inc. 31531 Eight Mile Rd, Livonia, MI 48152
Sales & Tech Help for Registered Owners (248) 473-9230 Fax: 248-442-7750
Email: feedback@performancetrends.com

Website (tips, correspond with other users, download demos, update schedule, etc.)
www.performancetrends.com

Copyright Notice
Copyright (C) 2017 Performance Trends, Inc. All Rights Reserved

These software programs and user's manual are reserved by Performance Trends, Inc. and are intended for the use of the original owner only. Copying or duplicating these products except for the personal use of the original owner is a violation of U. S. Copyright Law and is hereby expressly forbidden.

Portions Copyright (C) Microsoft Corp. All Rights Reserved

DISCLAIMER OF WARRANTIES:

THE SOFTWARE PROVIDED HEREUNDER IS LICENSED "AS IS" WITHOUT ANY WARRANTIES, EXPRESS OR IMPLIED, INCLUDING BUT NOT LIMITED TO, ANY WARRANTIES FOR MERCHANTABILITY OR FITNESS FOR A PARTICULAR PURPOSE. NO ORAL OR WRITTEN STATEMENTS, REPRESENTATIONS OR OTHER AFFIRMATION OF FACT, INCLUDING BUT NOT LIMITED TO STATEMENTS REGARDING CAPABILITY, CAPACITY, SUITABILITY FOR USE OR PERFORMANCE OF SOFTWARE SHALL BE RELIED UPON BY USER OR BE DEEMED TO BE A WARRANTY OR REPRESENTATION BY PERFORMANCE TRENDS, INC. FOR ANY PURPOSE, OR GIVE RISE TO ANY LIABILITY OF OBLIGATION OF PERFORMANCE TRENDS, INC. WHATSOEVER. USER ACCEPTS ALL RESPONSIBILITY FOR SELECTING THE SOFTWARE TO MEET USER NEEDS OR SPECIFIC PURPOSES. PERFORMANCE TRENDS INC. IS UNDER NO OBLIGATION TO FURNISH USER UPDATES OR ENHANCEMENTS EVEN IF FURNISHED TO OTHER USERS.

Continued on next page.

LIMITATION OF LIABILITY:

If at the time of delivery to the original User only there are any defects in the media on which the Software is provided, User's sole and exclusive remedy shall be the replacement of any media returned to Performance Trends, Inc. within 90 days of the receipt of the Software by User, or at Performance Trends Inc.'s sole option, a refund of the License fees paid to Performance Trends, Inc. by User.

IN NO EVENT SHALL PERFORMANCE TRENDS, INC. OR THIRD PARTIES WHO HAVE RIGHTS IN THE SOFTWARE BE LIABLE TO USER FOR LOSS OF PROFITS, INDIRECT, SPECIAL, INCIDENTAL OR CONSEQUENTIAL DAMAGES EVEN IF PERFORMANCE TRENDS, INC. IS AWARE OF THE POSSIBILITY OF SUCH DAMAGES.

IN THE EVENT ANY REMEDY HEREUNDER FAILS OF ITS ESSENTIAL PURPOSE, OR IN ANY OTHER EVENT, PERFORMANCE TRENDS INC.'S LIABILITY HEREUNDER SHALL NOT EXCEED ANY AMOUNTS PAID BY USER TO PERFORMANCE TRENDS, INC. UNDER THIS AGREEMENT.

Some states do not allow the limitation or exclusion of liability for incidental or consequential damages and some states do not allow the exclusion of implied warranties, so the above limitations or exclusions may not apply to you.

No action, regardless of form, arising out of any claimed breach of this agreement or performance under this agreement may be brought by either party more than one year after the affected party learns of the cause of action.

Refer to diskette envelope for full license agreement.

***** W A R N I N G *****

The Drag Racing Analyzer makes calculations based on equations and data found in various published and heretofore reliable documents. The program is designed for use by skilled professionals experienced with engines and vehicles. The following processes are hazardous, particularly if done by an unskilled or inexperienced user:

- Obtaining data to input to the program
- Interpreting the program's results

Before making measurements of or modifications to any vehicle, engine or driving situation, DO NOT FAIL TO:

- Regard the safety consequences
- Consult with a skilled and cautious professional
- Read the entire user's manual
- Obey all federal, state & local laws
- Respect the rights and safety of others

Table of Contents

Chapter 1 Introduction	1
1.1 Overview of Features	1
1.2 Before You Start	2
1.3 A Word of Caution	3
1.4 Getting Started (Installation)	4
1.5 Example to Get You Going	5
Chapter 2 Definitions	11
2.0 Basic Program Operation	11
2.1 Preferences	13
2.2 Engine	15
2.3 Transmission	21
2.4 Body & Axle	26
2.5 Wheels & Tires	34
2.6 Driving Specs	38
2.7 Calculated Performance Test Results	49
2.7.1 Calculate Performance Conditions	49
2.7.2 Calculate Performance Test Results	55
2.8 Calculation Menus	60
2.9 Match Vehicle Performance	74
2.10 Throttle Stop Prediction	77
2.11 Dial In Prediction	82
2.12 Example	87
Chapter 3 Output	91
3.0 Test Results	91
3.1 Analysis Report	93
3.2 Graphs	95
3.3 Vehicle Library	99
3.4 Printer Output	103
3.5 History Log	105

Chapter 4 Examples	107
Example 4.1 Finding the Best Axle Ratio	108
Example 4.2 Using the Match Vehicle Performance Option	119
Example 4.3 Predict Bracket Racing "Dial In"	132
Example 4.4 Predict Throttle Stop to Run Index	138
Appendix 1: Accuracy and Assumptions	143
Appendix 2: General Tips	147
Appendix 3: Version 3.2 Features	154
Appendix 4: Version 3.4 Features	163
Appendix 5: Version 3.4 B Features	169
Index	189

Chapter 1 Introduction

1.1 Overview of Features

The Drag Racing Analyzer program by Performance Trends, Inc. is a software system to let drag racers, performance enthusiasts, and even the average driver understand and predict many aspects of full power vehicle acceleration. The Drag Racing Analyzer, Version 3 has been designed to be easier, faster and more accurate. Several new features have been added and other features enhanced. The major changes in Drag Racing Analyzer Version 3 are listed below:

New Features:

- Mouse driven user interface compatible with Windows and Window 95 for easier operation and better print capability.
- Lots of example engines, transmissions, body styles, etc. preloaded for you to pick from.
- Several ways to input engine power, from just peak HP all the way up to a full power curve of 10 RPMs. You can also generate power curves from other simple inputs, your car's actual specs and performance (MPH), or in a Windows Engine Analyzer and import it directly.
- The Match Vehicle Performance option where you enter your car's actual stall RPM, 60 ft time, MPH, finish RPM, etc and the program adjusts critical specs to match your actual performance.
- You can have the program automatically pick 'near optimum' shift points.
- Customize the method of entering weather conditions in up to 6 different ways, including altimeter, corrected or uncorrected barometer, relative humidity or dew point. Also accepts wet/dry bulb temps.
- After you've calculated performance, the Analysis Report will make notes about the run and suggestions for improving performance.
- Converter stall RPM is automatically displayed as converter specs are changed.
- On screen help by simply clicking on any input spec.
- Graphs of Engine RPM, Acceleration Rate in Gs, Distance, MPH, available HP, etc to compare current results with a baseline run you can choose.
- Special Dial In and Throttle Stop prediction screens with separate Save, Open and Print features.
- A History log of the last 25 runs is kept to track your modifications.
- Calculation of Density Altitude and Dry Density Altitude (correcting for humidity level).

If you require more detailed analysis or more features, you may need our Drag Racing Analyzer "Pro".

Check Appendix 3, 4 and 5 for new features added to v3.2, 3.4 and 3.4 B.

1.2 Before You Start

What you will need:

- Computer capable of running Windows 98, Me, XP, 2000, NT, Vista, 7 or newer.
- Printer (optional).

Many terms used by the Drag Racing Analyzer and this user's manual are similar to terms used by other publications, like Converter Capacity, Tire Traction Factor, etc. However, these terms may have different definitions. Therefore, read Chapter 2 to see what these terms mean to the Drag Racing Analyzer.

Occasionally it will be necessary to identify "typos" in the manual, known "bugs" and their "fixes", etc. which were not known at the time of publication. These will be identified in a file called README.DOC in the Drag Racing Analyzer directory or folder.

A new feature also allows you to view the README.DOC file in the Drag Race Analyzer by clicking on Help at the main screen, then View Readme File. User Manuals and Supplements describing new features can also be viewed this way..

Every effort has been made by Performance Trends, Inc to provide you with an accurate, cost saving, high quality tool at a very reasonable price. We do not copy protect our software, to allow our customers full freedom to make back-up copies *for their own personal use*. Please respect the programmer's copyright and do NOT give out copies to your friends.

Important: The body of this manual covers v3.0's features. Check Appendix 3, 4 and 5 for new features added in v3.2, v3.4 and v3.4 B.

1.3 A Word of Caution

The Drag Racing Analyzer is a comprehensive software package which estimates a vehicle's performance based on limited user input. These estimates can be used for analysis of drag strip or normal street performance. A vehicle is a very complex system, which makes exact calculations of all details impossible. Therefore, several simplifying assumptions are made to reduce the calculations to a manageable level. See the Assumptions in Appendix 1. The user must recognize:

The software can not predict the safety of a vehicle modification or driving situation. Done correctly, with the proper quality parts and safety precautions, extreme vehicle conditions can be safe. Done by inexperienced racers with standard or low quality parts, a drag car can be a "disaster waiting to happen". Please read and follow the "Safety Notes" as highlighted in this manual.

The software, like any computer model, can NOT make exact predictions because:

- Much of the input data to the software is estimated.
- Even if the input data were exactly correct, the simplifying assumptions within the program will limit the accuracy.
- Environmental conditions, driver performance, track conditions, etc. are rarely constant and repeatable.

The software should be used as a guide to:

- Help you understand how an vehicle works; what parameters are important, how parameters interact, what are the tradeoffs, etc.
- Point you in the correct, general direction for making modifications. This direction should be verified by other sources like known authorities, time slips, books, etc. Never trust one "single source" if it does not make sense to you.
- Make you think, not think for you. If unexpected results are obtained, take a minute to:
 - Double check all your data input.
 - Refer back to this manual.
 - Ask someone else skilled and experienced in the particular area.
 - Give the retailer or Performance Trends Inc's. Tech Help Line a call for an explanation. (Computer programs are written by normal people who can make mistakes. It's always possible there may be an error in the calculations. Your phone call may help us correct it.)

Please also read the Warranty and Warning at the beginning of this manual and on the diskette envelope.

1.4 Getting Started (Installation)

You must install the Drag Racing Analyzer from the distribution disks (a CD in version 3.2, floppy disks in older versions) to a hard drive before it will run. To do this from a CD, simply install the CD in your CDROM drive and the Performance Trends Installation Wizard should automatically start, allowing you to install the Drag Racing Analyzer and demos of any of our other products.

If the CD does not auto-run, then click on Start, then Run, then Browse and find your CD drive. Then look for SETUP.EXE on the CD and run it to run the Installation Wizard. If you want to bypass the wizard, go into the Programs folder and run the Drag-Racing-Analyzer-v3.4-Installer.exe file.

Follow the instructions of the SETUP program. For most users, just click on OK for each

question asked to accept the default answers suggested by the Setup program. Once you have installed the Drag Racing Analyzer, there should be a Perf. Trends icon or program group for you to click on under "All Programs" after you click on Start at the lower left corner. There should also be a Drag Racing Analyzer v3.4 desktop icon you can double click on. That is how most users will start the program.

Entering Registered Owner's Name:

During your first setup, the Drag Racing Analyzer will ask you to enter your name as the Registered Owner. During this first session, you can modify it until you are satisfied. Once you accept the name, the computer will generate a code # based on the name. **Be sure you are happy with this name, as it will appear on printouts and on your screen.**

Click on About in the Main Menu to review your name and code # .

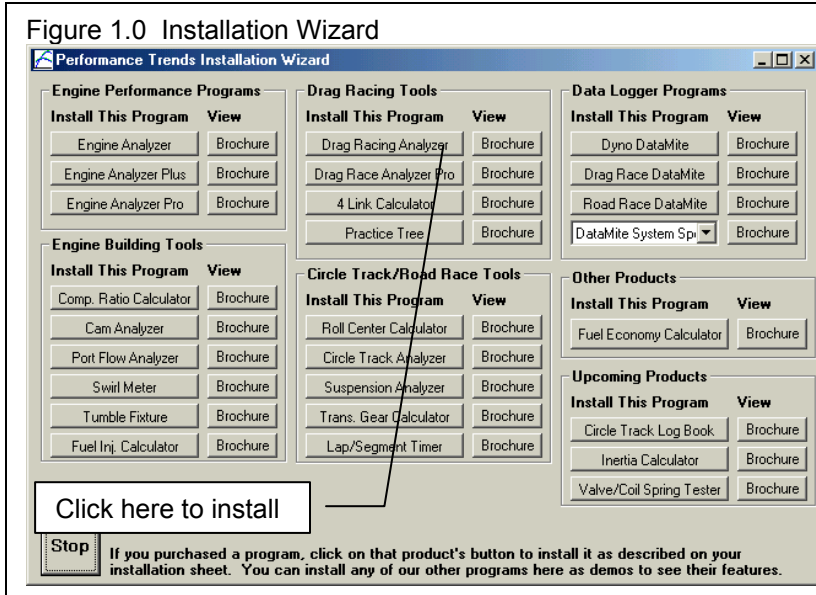

1.5 Example to Get You Going

To start the Drag Racing Analyzer, click on the Drag Racing Analyzer icon on your desktop. Or click on Start, then Programs, then Perf. Trends, and then Drag Racing Analyzer. After some brief introduction screens, you will be left at the Main Menu shown below.

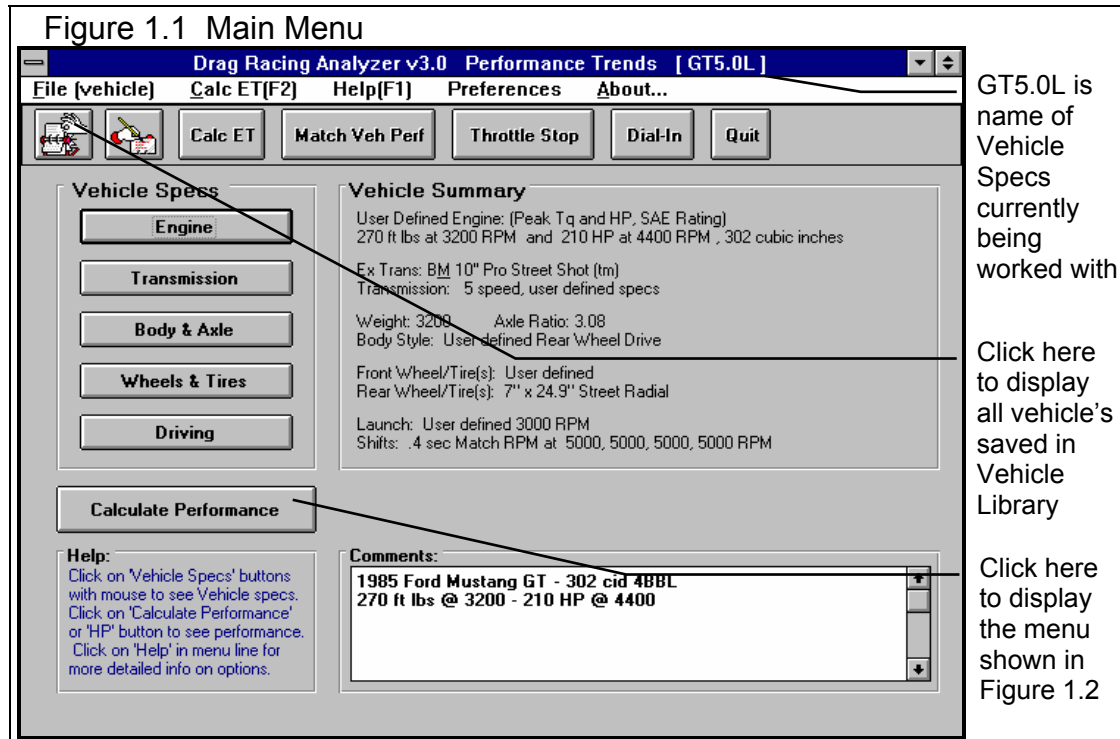

From this main menu, you can:

- Choose to review or modify any of the categories of vehicle specifications displayed.
- Open or Save a file of complete vehicle specifications by clicking on the Open or Save buttons (first 2 buttons on the left) or the File menu item, then either Open or Save.
- Add, edit or review vehicle comments to describe the vehicle currently held in the program.
- Calculate vehicle performance from the options listed under Calculate Performance. From here you can specify calculation options (barometric pressure, humidity, track length, etc.).
- Change the Preferences options to somewhat customize the program for you.
- Get HELP to explain these options by clicking on Help or pressing <F1>.
- Quit the program by clicking on File, then Exit, or click on the Quit button.

All these options are explained in detail in Chapters 2 and 3.

In the Main Menu's blue title bar you will notice the current Vehicle is [GT5.0L]. The program has descriptions of vehicles saved in the Library right from the factory. The current file from the Vehicle Library is called GT5.0L.

To get started, let's examine (but not change) the various categories of specs. Click on a button for one of the categories like Engine, Transmission, etc. A new menu will appear displaying the various specs and the current values for the GT5.0L vehicle. You can click on the name of any spec and a brief description appears in the Help frame, along with a page # from this manual for more help. You can return to the Main Menu by clicking on OK or clicking on an area outside this menu.

Now click on the Calculate Performance button in the Main Menu to calculate performance for this GT5.0L vehicle. The next menu will show you the Calculate Performance Conditions menu as shown in Figure 1.2.

For now, leave all the Calculation Conditions as they are and click on the Calculate Performance button. This will start the program calculating performance for the specifications of the GT5.0L stored in the Vehicle Library with the Calculation Conditions currently displayed. A progress bar graph shows how the calculations are progressing. The calculations may require several seconds on slower computers.

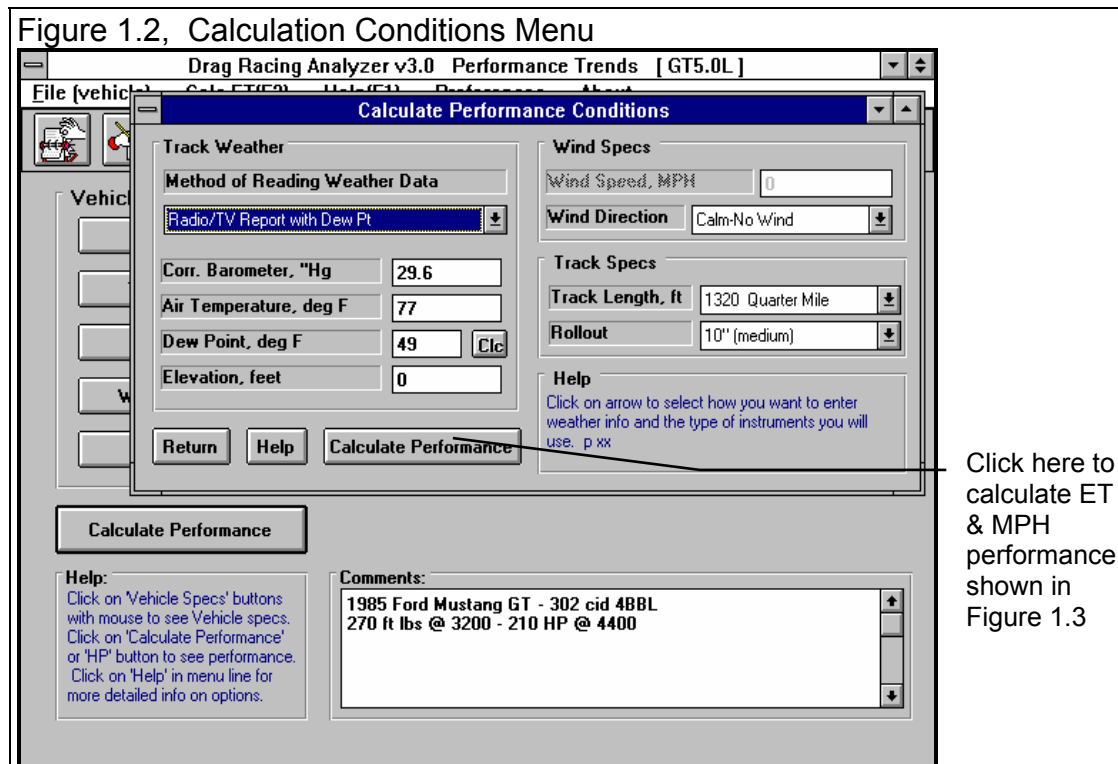

Click here to calculate ET & MPH performance shown in Figure 1.3

The final results will appear in a table as in Figure 1.3. The columns are for various types of readings (gear #, MPH, etc) which occurred at critical points in the run, like the start, the end of each gear, beginning of each gear, 60 foot time, 60 MPH, etc.

The results contain much information, some which may not be familiar to you. However, the first three columns do look familiar:

If you look at the last row, you see a Time of 14.54 and a MPH of 95.7, or the car ran a 14.54 ET at 95.7 MPH. If you look in the upper right corner you see a Summary of the Current and Last performance, including a "Improvement" or how much the current performance is better than the previous results. You'll notice that the 94.94 MPH in this section is slightly less than the MPH at the end of the MPH column. That is because a drag strip uses 2 timing lights spread over the last 66 ft of drag strip to measure top speed through the traps. These lights give a slightly lower MPH than the car actually ran at exactly 1320 feet. To summarize, the MPH in the Summary best matches the MPH on a quarter mile time slip.

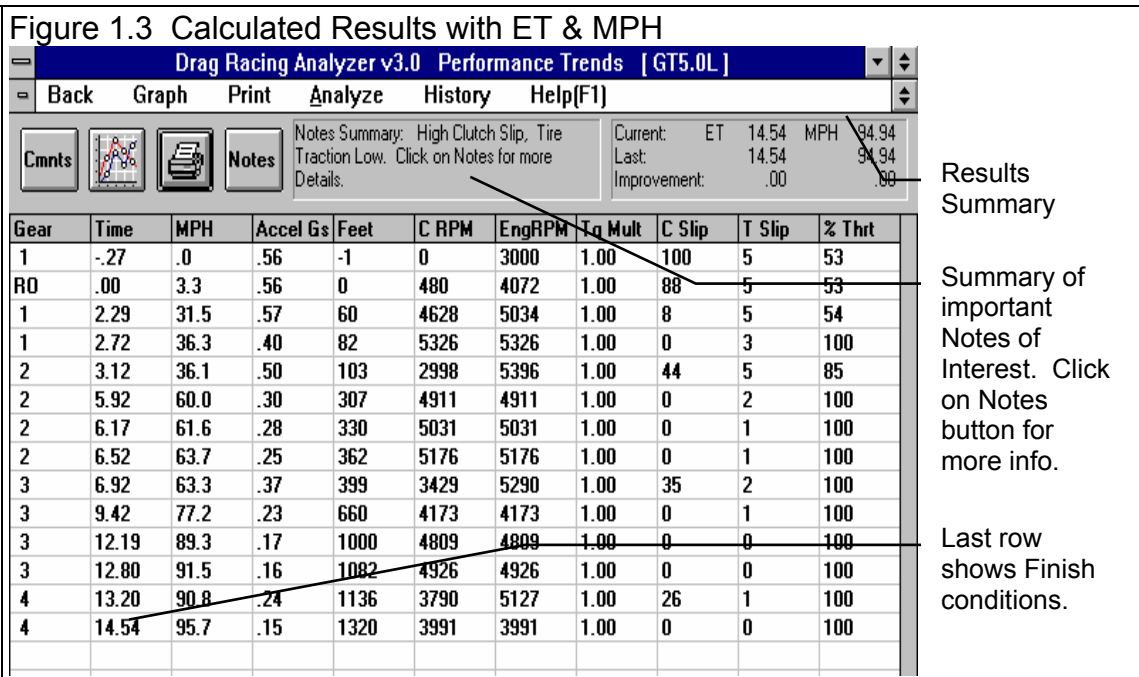

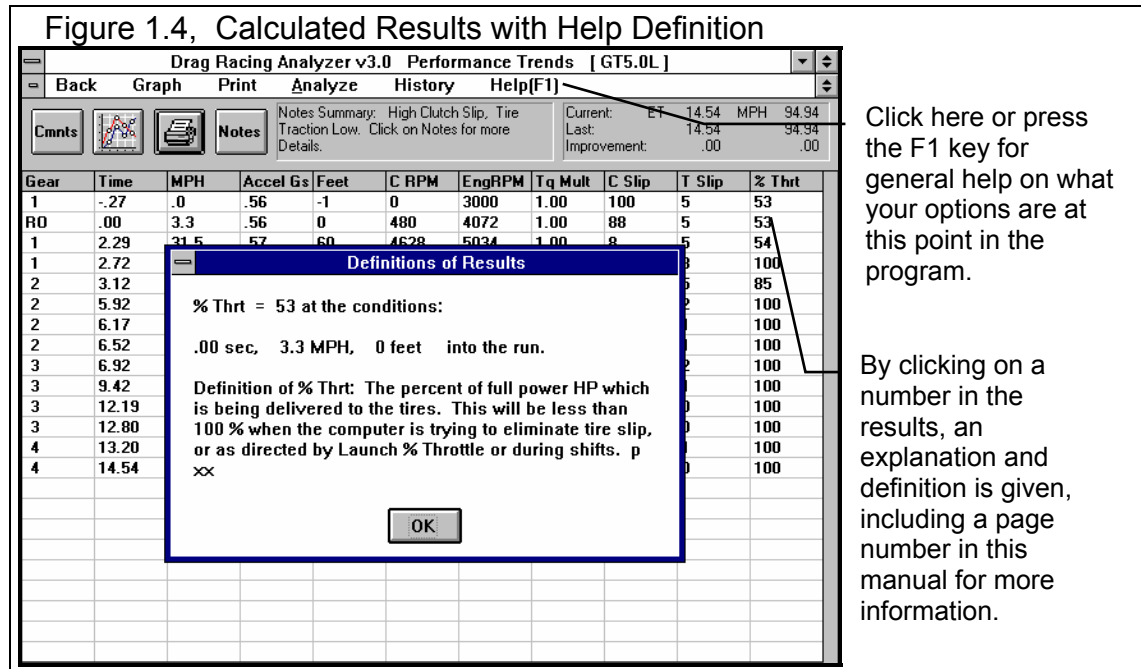

Click here or press the F1 key for general help on what your options are at this point in the program.

By clicking on a number in the results, an explanation and definition is given, including a page number in this manual for more information.

The menu bar and the command buttons at the top of the screen shows some of the options for various formats for data output:

- Analyze will produce a report of performance and safety tips on the test results
- Graph will produce various types of graphs. You can also compare the current results to results of the previous run, or some other Baseline you have saved.
- Print lets you print these results on your printer.

If you have a printer hooked up to your computer, try the Print command by clicking on Print in the menu bar or on the Printer button. A small menu of printout options are presented. These options allow you to enter a report comment, include vehicle specs and comments in the printout, etc. These options are explained in Section 3.4. For this first time, accept the default settings and print the report by clicking on Print Results.

To help explain the other columns of output, simply click on those results. A definition of that particular data will be presented in a Message box as in Figure 1.4. Then click on OK when you have read the definition.

For a detailed explanation of all the results, Calculation Conditions, and output options, go to Section 2.7 and Chapter 3.

Clicking on Back or pressing the <ESC> key will return you to the Main Menu. From the Main Menu you can modify the GT5.0L to see the effect on performance. For example you could go into any of the component menus and:

- Change to a different rear axle ratio.
- Install 'stickier' tires.
- Change weather or wind conditions.

The beauty of the program is that it repeats exactly each time. This lets you find differences which would be "clouded" by changes in track conditions or driver variations.

Many of the input specifications you see in the various menus may not be familiar to you. For a brief definition of the inputs, simply click on the specification name. The definition will appear in the Help frame with a page # in this manual for more info.

Some of the vehicle specifications have "Clc" buttons. One example is Dew Point in the Calculate Performance Conditions menu. "Clc" stands for "calculate". For example, if you want to calculate the Dew Point from wet and dry bulb readings, simply click on the Clc button. The program will display a new menu listing the inputs and the Calc Dew Point from these inputs. For further explanation, click on the Help buttons in these menus. To use the Calc Dew Point calculated from these inputs, click on the Use Calc Value button. Otherwise click on Cancel to return to the Calculate Performance Conditions menu with no change to Dew Point. Section 2.8, Calculation Menus explains all these calculations.

Once you feel comfortable changing specifications in the various menus and making various performance calculations, read Section 3.3 of this manual called Vehicle Library to learn how to save a set of vehicle specifications or recall information which has been previously saved. Then you will know all the basic commands to operate the program. For a more in-depth knowledge of using these commands and an explanation of the results, read this entire manual.

Chapter 2 Definitions

2.0 Basic Program Operation:

Figure 2.1 shows the Drag Racing Analyzer's Main Menu with explanations of your options here. Figure 2.2 shows the Body & Axle menu with explanations of options for most component menus.

Figure 2.1 Main Menu Options

The screenshot shows the main menu of the Drag Racing Analyzer v3.0. The menu bar includes File (vehicle), Calc ET(F2), Help(F1), Preferences, and About... The command buttons are Calc ET, Match Veh Perf, Throttle Stop, Dial-In, and Quit. The Vehicle Specs section includes buttons for Engine, Transmission, Body & Axle, Wheels & Tires, and Driving. The Vehicle Summary section displays user-defined engine, transmission, weight, axle ratio, body style, front/rear wheel/tire specs, launch, and shifts. The Comments section is a text area for describing the vehicle. The Calculate Performance button is located below the Vehicle Specs section. A Help section provides instructions on how to use the various buttons.

Buttons to display individual menus containing vehicle and driving specs.

Menu bar. Click here for "drop down" menus of program options, some being the same as the Command Buttons.

Name of current vehicle file

Command buttons to save or retrieve a vehicle file, calculate performance, and perform other special calculations

This area gives a general description or summary of each of the 5 menus of specs which make up a vehicle

Enter comments to describe vehicle

Click here to display Calculation Conditions (weather, track length, etc), and then calculate performance.

Move mouse over an area and a description of the item is given here

Figure 2.2 Explanation of Sections of Typical Menu

The screenshot shows a software menu titled "Body/Axle Specs". It is divided into several sections:

- Vehicle Weight:** A text box labeled "Vehicle Weight, lbs" containing the value "3200".
- Axle Specs:** Contains a "Final Drive Ratio" text box with "3.08" and a "Clc" button. Below it is a "Diff Lock Eff, %" dropdown menu showing "50% Prod 'Posi'".
- Body Details:** A section with multiple fields and buttons:
 - "Type" dropdown menu: "Use Specs Below"
 - "Driveline Layout" dropdown menu: "Rear Wheel Drive"
 - "% Wt on Rear Tires" text box: "40" with a "Clc" button
 - "Height of C.G., in" text box: "22"
 - "Wheelbase, in" text box: "101"
 - "Rear Track Width, in" text box: "57"
 - "Frt Roll Stfns, %" dropdown menu: "Modern Production"
 - "Frontal Area, sq ft" text box: "21" with a "Clc" button
 - "Drag Coefficient" text box: ".42"
- Help:** A text area containing the text "The weight of the vehicle with the driver in pounds. p xx".

At the bottom of the menu are four buttons: "OK", "Help", "Get Example", and "Save Example".

Name of specs. Click on them for a description in the menu's help frame.

Help frame giving definition of spec and page # in manual for more info.

Drop down combo box. Click on down arrow button on the right side to pick from a list of possible choices for this spec.

Standard text entry box where you can type in the value of the spec (which will be checked against acceptable limits).

Calculation button which opens up another menu where you can calculate the value of a spec from other inputs

Click here to close menu.

Click here to obtain 1 to several screens of help to explain this menu.

Click here to display lists of examples of specs for this menu

Click here to save the appropriate current specs in this menu as an example in the list of example specs.

Is the name of the example specs (if an example was used) or else called something like "Use Specs Below" where specs are not from an example or are modified from an example. Other options include "Let program estimate specs".

2.1 Preferences

Click on the Preferences item in the menu bar at the top of the Main Menu screen to drop down the Preferences shown in Figure 2.3. Here you can adjust some program items to personalize the program for your needs.

Sec Increments

Click on .01 for times like ET, 60 foot time, Dial In predictions, etc to be given to the nearest hundredth of a second. This will have calculations run about 5 times faster. If you have a faster computer and/or want better precision, select .001 for times to be calculated to the nearest thousandth of a second.

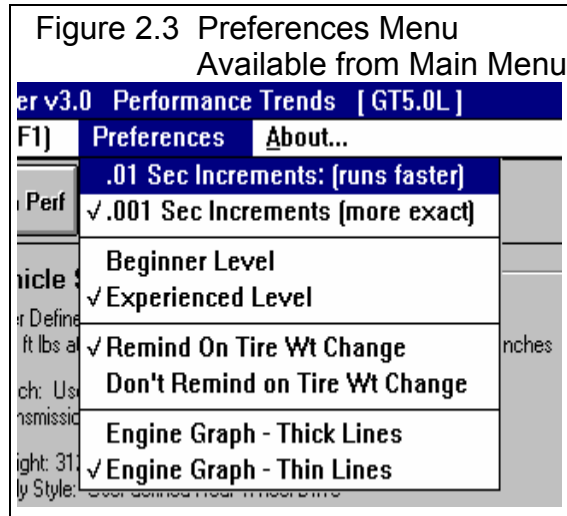

Beginner/Experienced Level

If you select Beginner, the program will lock out the more complicated features, make more checks on specs assuming you could be making mistakes, and gives more explanation before an action is performed (assuming you may not be familiar it). We strongly recommend this choice to anyone new to computers or this program.

Remind on Tire Wt Change

Select this option and the program checks if you have made a significant weight change to the wheels or tires in the Wheels/Tires menu. If you have the program will ask if you want the same weight change to be made to the total vehicle weight.

For example, if you are installing lighter wheels and tires on your street car, you probably want the vehicle weight lightened by the amount the wheels and tires are lighter than the original ones. However, if you are running a class where your vehicle weight must remain at a certain level, you can gain an advantage by reducing the weight of the wheels and tires (reducing rotating inertia), but then adding ballast to the car so the total weight stays the same. This is a case where you do not want the vehicle weight changed by the amount you lightened the wheels and tires.

Engine Graph - Thick Lines

Engine Graph - Thin Lines

Lets you customize the way the Full Power Curve graph in the Engine specs menu is displayed and printed.

2.2 Engine

The Engine specs describe the engine's size in cubic inches, its torque and HP, and what power correction was used for rating the engine's torque and HP.

Figure 2.4 Engine Specs Menu (shown with Full Power Curve)

Click here to set the amount of detail you want to give the program about the power curve. **For beginners, we strongly recommend selecting Peak HP Only or picking example power curves.**

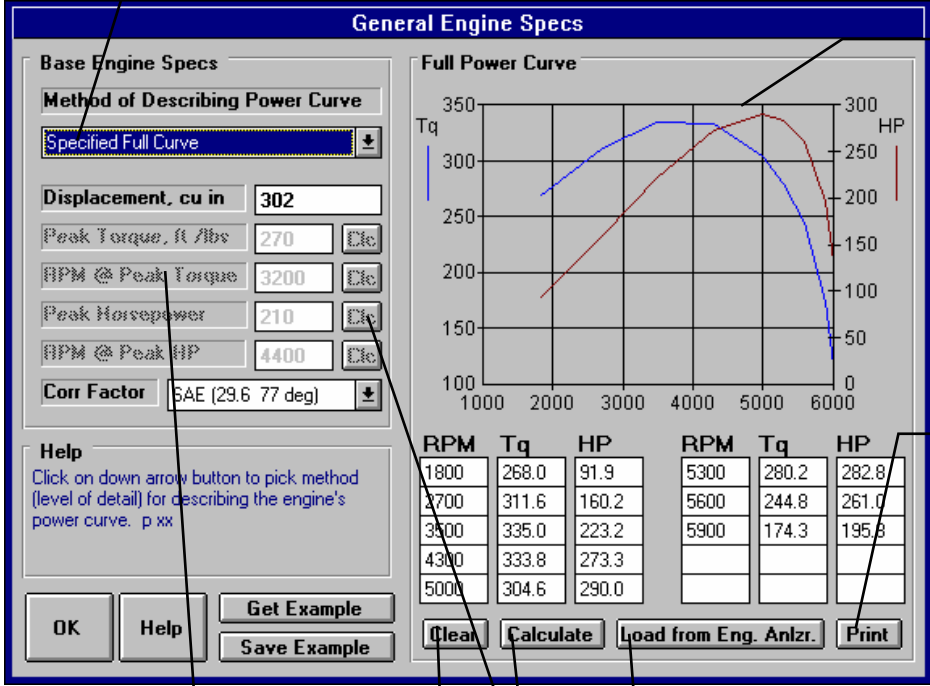

General Engine Specs

Base Engine Specs

Method of Describing Power Curve: Specified Full Curve

Displacement, cu in: 302

Peak Torque, ft/lbs: 270

RPM @ Peak Torque: 3200

Peak Horsepower: 210

RPM @ Peak HP: 4400

Corr Factor: SAE (29.6 77 deg)

Help: Click on down arrow button to pick method (level of detail) for describing the engine's power curve. p xx

Full Power Curve

Torque and HP graph based on data in table below it. Note that HP has a separate scale on the right side

RPM	Tq	HP	RPM	Tq	HP
1800	268.0	91.9	5300	280.2	282.8
2700	311.6	160.2	5600	244.8	261.0
3500	335.0	223.2	5900	174.3	195.8
4300	333.8	273.3			
5000	304.6	290.0			

Click here to print power curve and table.

Click here to load a power curve from an Engine Analyzer program

Click here or here to calculate power curve specs from other simple inputs.

Click here to blank out table to enter new numbers

Certain sections will be disabled (grayed out) depending on your choice of Method of Describing Power Curve

Buttons: OK, Help, Get Example, Save Example, Clear, Calculate, Load from Eng. Anlzt., Print

Method of Describing Power Curve

Click on the down arrow of this combo box for the following choices:

- Peak HP Only
- Peak Torque and HP Only
- Full Power Curve (which enables the 4 command buttons in this section as shown in Figure 2.4)
- Pick an Example
- Example: Example Name (if you have already chosen an example)

Depending on your choice, the appropriate sections, buttons and inputs will be disabled (grayed out) and you will not be able to access them.

Displacement, cu in

The engine's cubic inch displacement is used for 2 things:

- First it is used to determine the shape of the power curve from limited user input, especially in the case of specifying Peak HP Only.
- It is used to estimate the amount of rotating inertia * in the engine and clutch/flywheel or converter. The bigger the cubic inches, the larger the assumed rotating inertia.

Therefore, even if you are specifying the Full Power Curve, enter the cubic inches to let the program better estimate the engine's rotating inertia.

* Definition of Engine Inertia: The engine inertia is a measure of how massive the engine's rotating components are and how difficult it is to accelerate or decelerate the engine itself. Most of the engine's inertia is contained in the flywheel/clutch assembly for a manual transmission, or in the torque converter for an automatic transmission. The more massive or the larger the diameter the flywheel or any rotating engine component, the larger the inertia value.

Peak Torque, ft lbs

This is the maximum torque value for the vehicle's engine. This information is listed in magazine articles, owner's manual/repair manual or from dynamometer tests. See Appendix 2. If this value is not known, one of Performance Trends' Engine Analyzer programs will help you measure or estimate the engine's maximum torque. If you have no information on Peak Torque, we recommend you select one of the example curves, select the Method of Describing Power Curve of Peak HP Only to eliminate this spec, or click on the Clc button to calculate Peak Torque from other inputs.

RPM at Peak Torque

This is the RPM at which the peak torque occurs. This is listed in magazine articles, in the owners/repair manuals or dynamometer tests with the peak torque value (for example, 265 ft lbs @ 2800 RPM). The RPM at Peak Torque must be lower than the RPM at Peak HP. If you have no information on RPM at Peak Torque, we recommend you select one of the example curves, select the Method of Describing Power Curve of Peak HP Only to eliminate this spec, or click on the Clc button to calculate Peak Torque from other inputs.

Peak Horsepower

This is the maximum horsepower value for the vehicle's engine. This information is listed in magazine articles, in an owner's manual/repair manual or from dynamometer tests. See Appendix 2. If this value is not known, one of Performance Trends' Engine Analyzer programs will help you measure or estimate the engine's maximum horsepower. If you have no information on Peak Horsepower, we recommend you select one of the example curves, or use Calculation Menu by clicking on the Clc button, or use the Match Vehicle Performance option and let the program estimate your peak HP.

RPM at Peak HP

This is the RPM at which the peak HP occurs. This is listed in magazine articles, in the owner's/repair manuals or dynamometer tests with the peak torque value (for example, 189 HP @ 5200 RPM). The RPM at Peak HP must be higher than RPM at Peak Torque if you are using the Peak Torque spec. If you have no information on RPM at Peak HP, we recommend you select one of the example curves or estimate it at an RPM 500 RPM less than your shift RPM.

Corr. Factor

Since engine performance is strongly influenced by weather conditions, it is important to specify the conditions which give the torque and HP values you enter. For production engines, torque and HP values are corrected to conditions standardized by the Society of Automotive Engineers (SAE). These conditions are approximately 29.6" Hg, 77 degrees F and 49 degrees F dew point (humidity) as specified by SAE procedure J-1349. For these engines, click on the down arrow of this combo box and select "SAE (29.6 77 deg)".

Dynamometers which mostly test racing engines (typical of magazine articles) generally correct their data to 29.92" Hg, 60 degrees F and approximately 0 degrees F dew point (no humidity). For these engines, select "Std Dyno (29.92 60 deg)".

Full Power Curve Features

There are several ways to load in RPM, torque and HP data into the table on the right side of the Engine menu. You can Calculate one based on simple inputs, you can load an Example curve, you can load a curve calculated from one of our Windows Engine Analyzer Programs, or you can simply type in readings. If you type in readings, as soon as there 2 readings for any set of 3 inputs, the 3rd one is automatically calculated and filled in, and the new point is added to the graph.

The graph always shows a sharp drop in power after the highest RPM point in the table. This is to remind you that this is what the program assumes for calculations, that engine power drops significantly (like it ran into an overspeed) after the highest RPM. If you want the power to not drop so suddenly, then you must add an additional RPM above your current highest RPM, and enter a HP reading which draws the curve like you expect it to look.

Command Buttons

Three of the command buttons in the Full Power Curve section are rather self explanatory:

- Clear will blank out all the RPM, torque and HP entries.
- Calculate will calculate a power curve from simple inputs. See Section 2.8.1 on this Calculation Menu, which is the same as the Clc buttons bring up for the simpler power curve inputs in the left section.
- Print will print the graph and table of power curve data.

The other command "Load from Eng. Anlzd." will be discussed in more detail below.

Load from Eng. Anlzd.

The Drag Racing Analyzer can load engine power curves created by the proper Windows versions of Engine Analyzer EZ, the standard Engine Analyzer, and Engine Analyzer Pro. It is recommended that both the Engine Analyzer and Drag Racing Analyzer are loaded on a hard drive (C or D drive).

Generally you will start this process by running the Engine Analyzer program first. Once the Calculated Performance results have been calculated and displayed on the screen, click on the Send button in the Engine Analyzer. This Engine Analyzer menu looks similar to Figure 2.5. It will ask what program do

you want to send the power curve to, where you could click the Drag Racing Analyzer option. There are other options which you can refer to your Engine Analyzer manual.

The process of loading Engine Analyzer results into Drag Racing Analyzer is nearly automatic and consists of:

1. Once you've selected the Drag Racing Analyzer as the program to Send the results to, click on the OK/Send button in the Engine Analyzer's Send menu to leave the Engine Analyzer.
2. The Drag Racing Analyzer will be automatically activated and run.
3. When the Drag Racing Analyzer starts up the first time, you are given notice that a power curve is available and can be loaded from the Engine specs menu. You will also notice some new commands on the Main Menu called "Engine Analyzer". Clicking on these will return to control to the Engine Analyzer program which originally called the Drag Racing Analyzer, but will leave the Drag Racing Analyzer also running, ready for a new power curve.
4. Important: Once you load the power curve, the old power curve is gone, unless you saved the vehicle specs including power curve with the Save command or saved it as an Example by clicking on the Save Example button at the Engine specs menu.
5. When you are ready to return to the Engine Analyzer, simply click on one of the Engine Analyzer buttons (at the Main Menu or in the Test Results screen) or commands in the Menu bar. You do not have to load the power curve. You can jump between the Engine Analyzer and Drag Racing Analyzer as many times as you want.

If an Engine Analyzer program is not currently running and "talking" to the Drag Racing Analyzer, you can also start the process by clicking on the Load from Eng. Anlznr. button. You will get the screen of Figure 2.5.

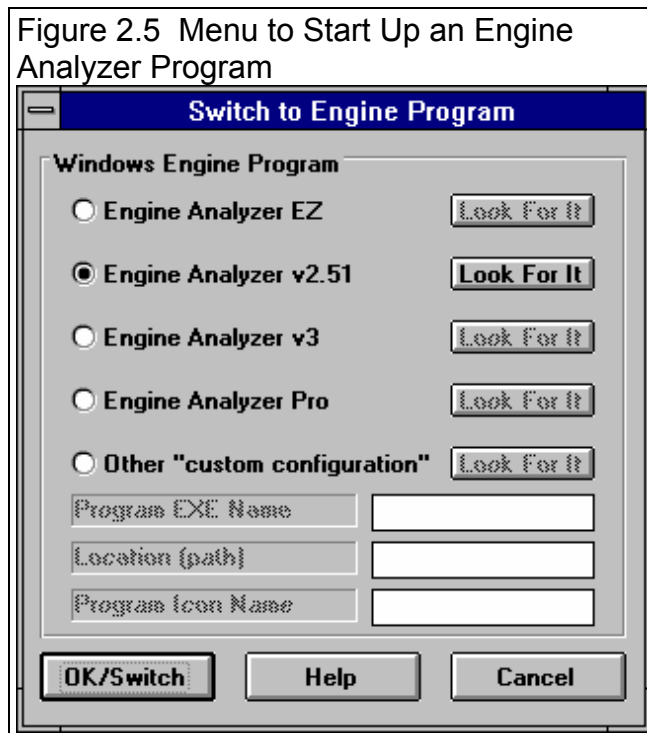

Troubleshooting

If this process of loading power curves into the Drag Racing Analyzer from the Engine Analyzer does not work like described above, consider the following.

- You do not own the correct Windows version of Engine Analyzer program.
- You have renamed the Drag Racing Analyzer or Engine Analyzer executable (.EXE) file.

The Drag Racing Analyzer should be DRA.EXE.

- In the Engine Analyzer program, click on the “Look for It” button by the Drag Racing Analyzer option to see if the program can find a correct Windows version.
- You are trying to help the programs transfer control to each other. Do not minimize one of the programs, then activate the other program as this can confuse the process.

2.3 Transmission

The Transmission specs describe the clutch or torque converter and the transmission's efficiency and gear ratios.

Appendix 5, page 169, New Features in v3.4 B discusses new transmission inputs added.

Figure 2.6 Transmission Specs Menu

Click here to select either clutch or torque converter, to let the program estimate clutch specs or to pick an example clutch or torque converter.

Click here (on on Pick Example button below) to pick an example.

For torque converters, full power stall RPM is shown here for the current engine power curve and track weather conditions. Refer to this as you adjust converter capacity, or simply enter your full power Stall RPM here and the Capacity will be figured for you.

Clutch/Converter

Type

Identifies if coupling between the engine and the transmission is through a friction clutch or hydrodynamic torque converter consisting of an impeller, turbine and reactor (or stator), typical of most automatic transmission converters. Click on the down arrow of this combo box for the following choices:

- Let Program Estimate Clutch Specs (recommended for most users using clutches)
- Use Clutch Specs Below
- Pick Example Clutch
- Use Converter Specs Below
- Pick Example Converter
- Example: Example Name (if you have already chosen a clutch or converter example)

Depending on your choice, the appropriate sections, buttons and inputs will be disabled (grayed out) and you will not be able to access them.

Clutch Diameter, inches

Identifies the outside diameter of the clutch disk measured in inches. If the Clutch Diameter can not be easily measured, let the program estimate it by selecting the Type called Let Program Estimate Clutch Specs.

Clutch Force, lbs

Identifies the clamping force the pressure plate exerts to squeeze the clutch disk(s). Manufacturers of aftermarket, racing type pressure plates generally specify this force in lbs (pounds of force). If you do not know this force, let the program estimate it by selecting the Type called Let Program Estimate Clutch Specs.

Clutch Disks

Is the number of clutch disks, which will be 1 for most all production type clutches. Only special racing clutches will have more than 1 disk, perhaps 2, 3 or 4 disks. If you do not know the # Clutch Disks, let the program estimate it by selecting the Type called Let Program Estimate Clutch Specs.

Clutch Material

Is the material of the clutch disk, either organic (sometimes called a “rag” clutch which is an older style material) or metallic (which is common in most racing clutches). If you do not know the Clutch Material, let the program estimate it by selecting the Type called Let Program Estimate Clutch Specs.

Converter Capacity

Describes the size or capacity of the torque converter in units of RPM per square root of torque (ft lbs). The higher the capacity (sometimes called "K" factor), the higher the converter slip for a given amount of input torque. High capacity converters are generally smaller in diameter, have internal blade modifications and are rated by their stall RPM for a given amount of engine input torque. Stall RPM is the engine RPM at full throttle when the converter output RPM is 0, which occurs with the transmission in gear with the drive tires not turning (trans brake is On).

Technically, if you know the engine's torque at stall, Converter Capacity can be calculated by the following equation:

$$\text{Converter Capacity} = \sqrt{\frac{\text{Stall RPM}}{\text{Engine Torque @ Stall}}}$$

High capacity torque converters are used in drag racing primarily to allow the engine to rev into it's high RPM power band at the line. However, high capacity converters generally have more slip at high speed, possibly lowering your quarter mile MPH.

Note: You may wonder why you can't just use the converter's stall RPM, instead of Capacity. The fact is a converter does not have a single stall RPM, but a different stall RPM for various amounts of engine torque.

For example, when an engine is idling against a stalled torque converter the "stall RPM" is the idle RPM. Open the throttle slightly and produce more torque and the "stall RPM" increases. How stall RPM changes with various amounts of engine torque is defined by Converter Capacity. Only by using Converter Capacity can you accurately see how stall RPM and vehicle performance changes with changes in engine output torque. Engine torque can be affected by many things, including weather, % throttle, engine modifications, etc.

Conv Tq Multiplication

Describes the amount of torque multiplication produced by the torque converter at stall (when the drive tires are not turning). A torque converter increases engine torque at stall, similar to a gear box. As the vehicle starts to move and converter output RPM increases, torque multiplication drops. At higher converter output RPMs, torque multiplication eventually reaches 1:1 (no torque multiplication but no torque loss). The Conv Tq Multiplication spec is generally not available from converter manufacturers (but it should be). Unless you know your converter's torque multiplication, use a value of 2.

Transmission

Type

Click on the down arrow of this combo box for the following choices:

- Use Specs Below
- Pick Example Transmission
- Example: Example Name (if you have already chosen a transmission example)

The major differences between an automatic or manual transmission in this program are:

- An automatic transmission uses a torque converter. This you select in the Clutch/Converter section.
- An automatic transmission has higher power losses due to the pump and larger areas for fluid friction. This is represented by the Efficiency, % spec in the Transmission section.

The program will let you combine a clutch with an automatic transmission (lower Efficiency rating) or a torque converter with a manual transmission (higher Efficiency rating). It also lets you combine any combination of example clutches, converters and transmissions.

Efficiency, %

Is the amount of power which actually leaves the transmission compared to the amount which entered the transmission gets from the engine. Automatics are about 3-6 % less efficient than manual transmissions. The more "heavy duty" the transmission, the less efficient (larger bearing areas). The fewer the number of gears, the more efficient the transmission. Click on the down arrow key to pick an efficiency from the list. Examples of transmissions with these efficiencies are also given in this list.

Note: You can pick any efficiency, even though the label does not match your car. For example, say you are working with a Ford C6 rated at "88% 60s Hvy Dty 3 spd Auto". You have made some improvements like going to a lighter fluid. Simply select an efficiency which is 1 to 2% higher than what you currently have Efficiency set at, even though 89% is called "89% 60s AWD 3 & 4 spd Auto". The Efficiency of 89% is still slightly better than 88%, even though you do not have All Wheel Drive.

- First (1) Gear Ratio
- Second (2) Gear Ratio
- Third (3) Gear Ratio
- Fourth (4) Gear Ratio
- Fifth (5) Gear Ratio
- Sixth (6) Gear Ratio

Are the gear ratios in the transmission. If you do not know your transmission's gear ratios, select one of the examples. Even though your transmission is not listed, select one with the same number of gears. This will be closer than guessing.

Appendix 5, page 169, New Features in v3.4 B discusses new transmission inputs added, including allowing up to 10 gear ratios.

2.4 Body & Axle

The Body & Axle specs describe the vehicle size, weight, suspension, final drive system and aerodynamics.

Figure 2.7 Body & Axle Specs Menu

Vehicle Weight and Final Drive Ratio (rear axle ratio) are very critical for accurate predictions.

Select to pick an Example of Body Details Specs or select Use Specs Below and enter in your own specs.

Body/Axle Specs	
Vehicle Weight	
Vehicle Weight, lbs	3200
Axle Specs	
Final Drive Ratio	3.08 <input type="button" value="Clc"/>
Diff Lock Eff. %	50% Prod 'Posi' <input type="button" value="v"/>
Body Details	
Type	Use Specs Below <input type="button" value="v"/>
Driveline Layout	Rear Wheel Drive <input type="button" value="v"/>
% Wt on Rear Tires	40 <input type="button" value="Clc"/>
Height of C.G., in	22
Wheelbase, in	101
Rear Track Width, in	57
Frt Roll Stfns. %	Modern Production <input type="button" value="v"/>
Frontal Area, sq ft	21 <input type="button" value="Clc"/>
Drag Coefficient	.42
<input type="button" value="OK"/> <input type="button" value="Help"/> <input type="button" value="Get Example"/> <input type="button" value="Save Example"/>	

Vehicle Weight

Vehicle Weight, lbs

Total vehicle weight in pounds with the driver. *For accurate predictions the weight you enter here is critical.*

Axle Specs:

Final Drive Ratio

For rear wheel drive vehicles, this is the rear axle ratio; for front wheel drive vehicles, this is the gear ratio of the final drive gear or chain system in the transaxle. For chain drive vehicle's (go carts, motorcycles, etc.) this is the chain ratio. For motorcycles with a gear reduction between the engine and the transmission, you must multiply the chain ratio by this gear reduction to obtain the total Final Drive Ratio. Click on the Clc button to obtain a menu to calculate Final Drive Ratio based on number of teeth for your particular situation.

This information is available in magazine articles, owner's-repair manuals, on tags attached to the vehicle, or coded into the vehicle's identification number.

One method of estimating the final drive ratio of a rear wheel drive vehicle *without locked differentials* (where the driveshaft is exposed) is to jack one of the rear tires off the ground, leaving the other rear tire on the ground. Mark a spot on the driveshaft. Rotate the tire which is off the ground exactly 2 complete revolutions. The other tire must remain still (which it will if you do not have a locked differential). Count the number of revolutions the driveshaft turns. This indicates the final drive ratio. For example, if the driveshaft turns 3.5 times, the final drive ratio is 3.5.

If you have a locked differential, the procedure is the same except you must have both rear wheels off the ground, and you rotate the tire only 1 turn (not 2).

Safety Precaution: This procedure should be attempted only by experienced mechanics, taking the proper safety precautions. This procedure may not be possible for racing axles with locking differentials or "spools".

Diff Lock Eff, %

The final drive differential in either a front wheel drive's transaxle or rear wheel drive's rear axle can be either a locking type ("posi-traction", "traction-lock", etc.) or an "open differential" with no locking. The locking type of differential tries to put the most power to the drive tire with the most traction.

Production locking differentials do not do this perfectly, but some racing differentials do lock up completely. Perfect lockup (100% lockup) can also be accomplished by welding the differential gears solid or by installing a "spool" to replace the differential. Both of these modifications cause problems when turning corners, since now both drive tires must turn at exactly the same speed.

The effectiveness of the differential's lockup also depends on the type of suspension for the drive axle. Click on the down arrow of this combo box to select the description which best describes your car.

Notes:

This specification is ignored if the Driveline Layout is set to Front or All Wheel Drive or Motorcycle. For Front Wheel Drive, the computer assumes a high % lockup due to the front wheel drive's assumed independent front suspension.

If the lockup is specified as 100%, then the specifications Rear Track Width and Frt Roll Stfns have no effect on the results and are disabled.

Body Details

Type

Click on the down arrow of this combo box for the following choices:

- Use Specs Below
- Pick Example Body
- Example: Example Name (if you have already chosen a body example)

Driveline Layout

Click on the down arrow of this combo box to tell the program where the driving wheels are, or if you have a motorcycle. If you specify All Wheel Drive (same as 4 wheel drive), be sure to select a lower Transmission Efficiency to account for extra losses in the transfer case.

% Wt on Rear Tires

Describes the vehicle's weight distribution, indicating the % of the vehicle's total weight which is on the rear tires. This information can be found in magazine road tests or owner's/repair manuals. An example would be "weight distribution = 55/45" which indicates 55% of the vehicle's weight is on the front tires when the vehicle is stationary, and 45% is on the rear tires.

It is also possible to measure the vehicle's weight distribution by weighing the vehicle with all 4 tires on the scale, and then weighing it with only the rear tires on the scale. (Both weighings should be done with the driver and with the vehicle level.) Then use the formula:

Formula to Calculate % Wt on Rear Tires

$$\% \text{ Wt on Rear Tires} = \frac{\text{Wt for Rear Tires Only}}{\text{Total Vehicle Weight}} \times 100$$

For example, if the total vehicle weight is 4000 lbs and the rear tire weight is 1800, the Weight on Rear Tires is $1800 / 4000 \times 100\% = 45\%$.

Since % Wt on Rear Tires has a Clc button, this calculation is computerized as shown in Section 2.8.3.

Height of CG

Describes the height of the vehicle's center of gravity from level ground. A sports car will have a lower CG than a 4WD truck. Increasing the height of the CG (installing a lift kit) will improve weight transfer and therefore traction in a rear wheel drive car for improved acceleration capabilities.

Safety Precaution:

Transferring this weight to the rear means less weight is being applied to the front tires. Therefore, steering control can be adversely affected creating unsafe conditions.

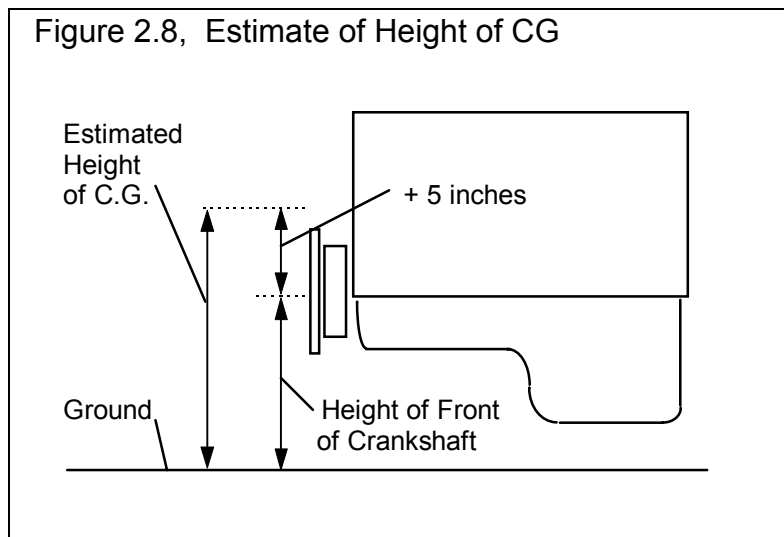

This information is not readily available, but can be estimated by measuring the distance from the ground to a spot approximately 5 inches above the center of the engine's crankshaft at the front of the engine (typical V-8 camshaft level).

Estimate the Height of CG of motorcycles as half way between the rider's shoulders and the engine's crankshaft. For example, if the height of the rider's shoulders is 40" and the crankshaft centerline is 14", the Height of CG would be $(40 + 14) / 2 = 27"$. Obviously, driver position has a significant effect on this parameter.

Wheelbase

Is the distance in inches from the center of the front wheels to the center of the rear wheels. Decreasing the wheelbase will improve weight transfer and therefore traction and E.T. on a rear wheel drive car.

Rear Track Width, in

Is the distance in inches from the center of one rear tire's track to the center of the other rear tire's track. This value is used in conjunction with Frt Roll Stfns, % for determining how RWD vehicles "lift" the right rear tire. For front wheel drive cars, certain assumptions are made about the suspension, and this value is disabled.

Frt Roll Stfns, %

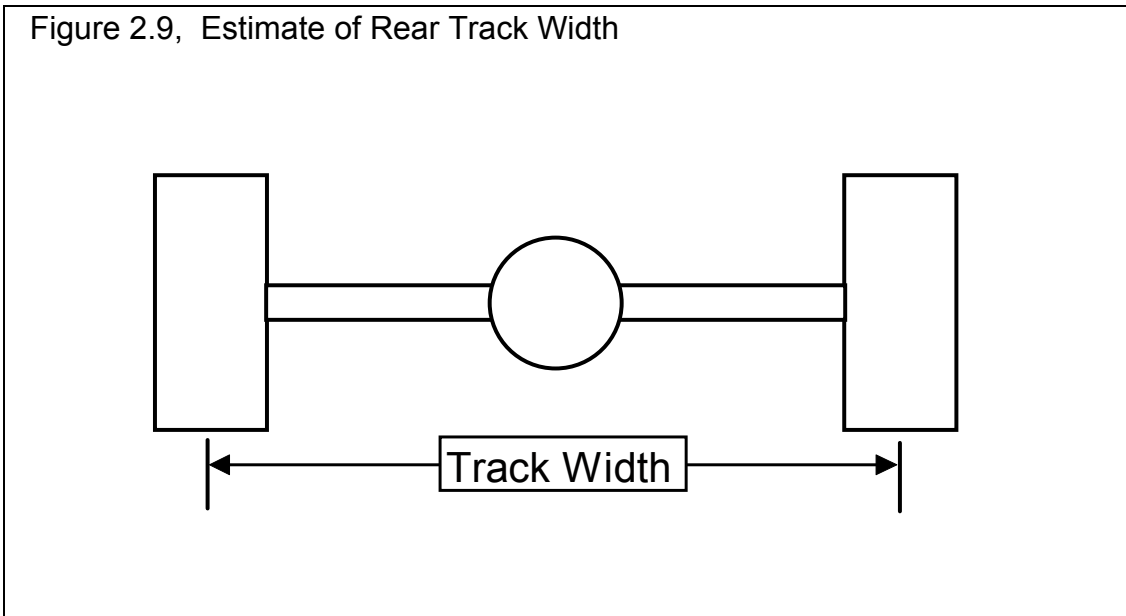

Roll stiffness is the suspension's resistance to leaning as it goes through a cornering maneuver. Part of the vehicle's total roll stiffness comes from the front suspension, and the rest comes from the rear. Frt Roll Stfns, % is the percent of the vehicle's total roll stiffness present in the front suspension.

For example, if the vehicle has a heavy rear anti-sway bar with stiff rear shocks, and no front anti-sway bar with soft front springs and shocks, only 25% of the vehicle's roll stiffness may be from the front suspension. This particular set-up is good for "planting" both rear tires on the ground for good traction with a rear wheel drive car.

Assume the Frt Roll Stfns, % is 75% (typical of most production cars) unless special modifications have been done to the suspension for drag racing. Then reduce it to a value of 25-50%. For front wheel drive cars, certain assumptions have been made about the suspension, and this value is disabled.

Frontal Area, sq ft

The frontal area is the area in square feet the vehicle's silhouette occupies when viewed from the front. Use the formula in Fig 2.10 to estimate frontal area. Frontal areas are in the range of 5 sq ft for a motorcycle, to 20 sq ft for a small passenger car to 30 sq ft or more for a full size pick-up truck. Also see Section 2.8.4 for calculating Frontal Area, sq ft by clicking on the Clc button.

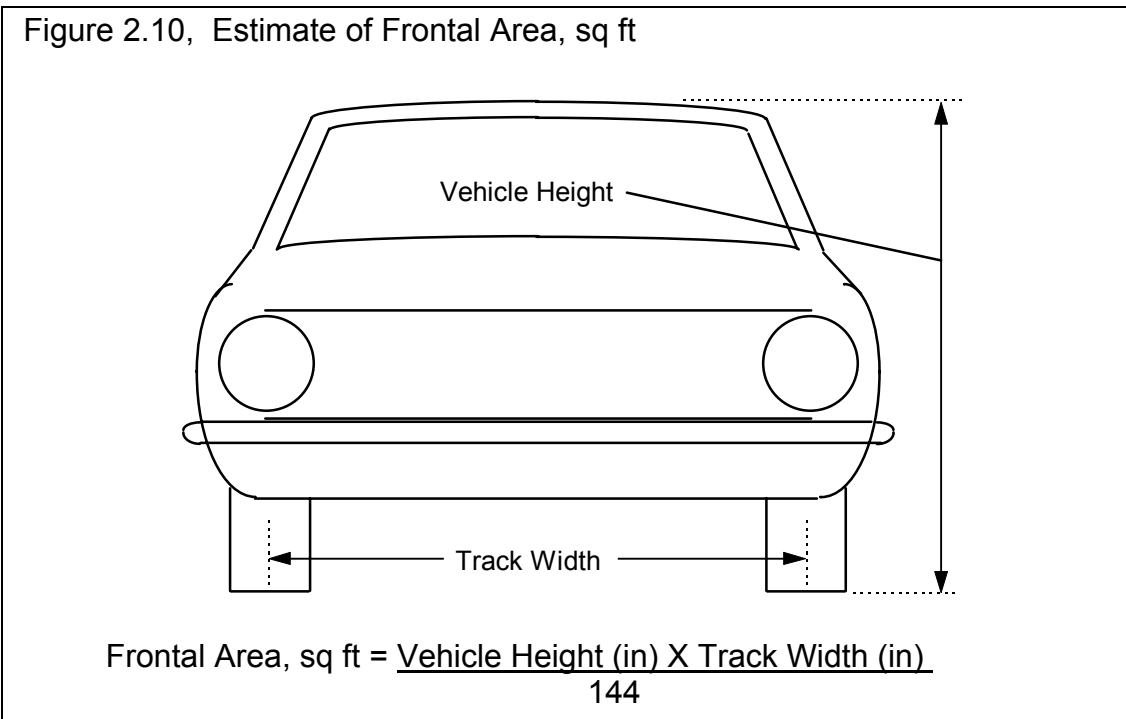

Drag Coefficient

The coefficient of drag (Cd) is an engineering term used to describe how aerodynamic a vehicle's exterior design is (how easily it "slices" through the wind). A low value for the Cd indicates the car is aerodynamic and requires little power from the engine to overcome wind resistance. Many automotive manufacturers now publish the vehicle's Cd in advertising, since an aerodynamic car is a more fuel efficient car. An aerodynamic car is also a faster car. If the actual Cd of a particular vehicle can not be found, use Table 2.1 to estimate the Cd for different types of vehicles. Use Table 2.2 to estimate how much Cd will change from a modification. A more complete list is by selecting one of the examples of Body Details.

Table 2.9: Estimate Drag Coefficient (Cd)

Type of Vehicle or Modification	Cd
Motorcycle	.70-1.10
Modern Motorcycle (fairings, etc.)	.50-.70
Pickup Truck	.50-.70
Sedan before 1980	.45-.60
Sports Car before 1980	.45-.55
Open Convertible	.50-.70
Modern Aerodynamic Sedan	.35-.45
Modern Aerodynamic Sports Car	.30-.40
"Best Case" vehicle	.11

Table 2.10: Estimate How Modifications Affect Cd and Cl (lift coefficient)

Modification	Change Cd	Change Cl (lift)
-4 deg Angle of Attack (vs stock) *1	-.04	-100%
+4deg Angle of Attack (vs stock)	+.04	+100%
Open Side Windows (vs closed)	+.02	
Open T-Top & Side Windows	+.08	
4" Flat Air Dam (width of vehicle) *2	-.04	-25%
8" Flat Air Dam (width of vehicle)	.00	-50%
12" Flat Air Dam (width of vehicle)	+.08	-55%
1" Flat Spoiler (width of vehicle) *3	-.03	-15%
2" Flat Spoiler (width of vehicle)	.00	-25%
4" Flat Spoiler (width of vehicle)	+.08	-35%
Blocking half radiator air flow	-.04	-35%

Notes concerning Table 2.1 and 2.2:

1* Change the vehicle's attitude from the production attitude 4 degrees, where a negative angle of attack is when the front is lowered and the rear is raised.

- 2* For this table, an air dam is defined as a flat plate the full width of the vehicle projecting vertically down directly below front bumper (based on typical 1970s or earlier design). Most modern designs integrate air dams for optimum Cd, therefore adding an air dam to a modern vehicle will likely show an increase in Cd but perhaps a reduction in Cl.
- 3* For this table, a spoiler is defined as a flat plate extending the full width of the vehicle at the top rear edge of the rear deck (trunk) lid, angled back 20° from vertical.
- Cl is the lift coefficient and is listed only to give the reader an indication of the trade off between aerodynamics and lift. Race vehicles want to minimize lift for better traction.
 - Table 2.2 shows typical effects from modifications. Individual vehicle's can differ considerable.
 - Advertised Cds are usually the "best case". For a realistic Cd, add .03 to .05 to the advertised Cd.

2.5 Wheels/Tires

The Wheels/Tires Specs describe the front and rear wheels and tires on the vehicle.

Figure 2.11 Wheels/Tires Menu

Specs in this right hand section are critical to traction, and therefore have a large effect on ET, 60 foot times, etc.

Wheel & Tire Specs

Front Wheel/Tire Specs

Type: Use Specs Below

Wheel & Tire Wt, lbs: 50

Tire Diameter, in: 25.00 [Clc]

Help
Click on down arrow button to pick a method of describing the type of wheel & tire. p 19

Rear Wheel/Tire Specs

Type: Use Specs Below

Wheel & Tire Wt, lbs: 50

Tire Diameter, in: 24.9 [Clc]

Construction: Street Radial

Tread Width, in: 7 [Clc]

Traction Factor, %: 90 [Clc]

Tire Growth, %: 10

OK Help Get Example Save Example

Front Wheel/Tire

If you have specified Front Wheel Drive as the Driveline Layout in the Body & Axle menu, this section will be labeled Rear Wheel/Tire. These wheel and tire specs are only used to estimate the inertia losses of accelerating these wheels and tires.

Type

Click on this combo box to select to Let Program Estimate Specs (recommended for most situations unless you are trying to estimate rolling inertia effects), Use Specs Below or Pick an Example.

Wheels & Tires Wt, lbs

This is the weight of *one* wheel/tire assembly, which can be obtained by weighing the tire mounted on the wheel on a weighing (or bathroom) scale. The program assumes there are 2 front wheels and tires on the vehicle unless you have specified Motorcycle as the Driveline Layout in the Body & Axle menu.

Tire Diameter, inches

The diameter of the tire is the distance from the tread across the center of the wheel to the other tread. This is sometimes referred to as how tall the tire is. See Tire Diameter in the Rear Wheel/Tire section below for more details.

Rear Wheel/Tire Specs:

If you have specified Front Wheel Drive as the Driveline Layout in the Body & Axle menu, this section will be labeled Rear Wheel/Tire.

Wheels & Tires Wt, lbs

This is the weight of *one* wheel/tire assembly, which can be obtained by weighing the tire mounted on the wheel on a weighing (or bathroom) scale. The program assumes there are 2 front wheels and tires on the vehicle unless you have specified Motorcycle as the Driveline Layout in the Body & Axle menu.

Tire Diameter, inches

The diameter of the tire is the distance from the tread across the center of the wheel to the other tread. This is sometimes referred to as how tall the tire is. For example, for 10 x 32 inch slicks, the 32 refers to the diameter of the tire.

This term has been changed from previous versions of Drag Racing Analyzer which used the input of Rolling Radius, or the distance from the center of the wheel to the tread on the ground. This is approximately half of the Tire Diameter.

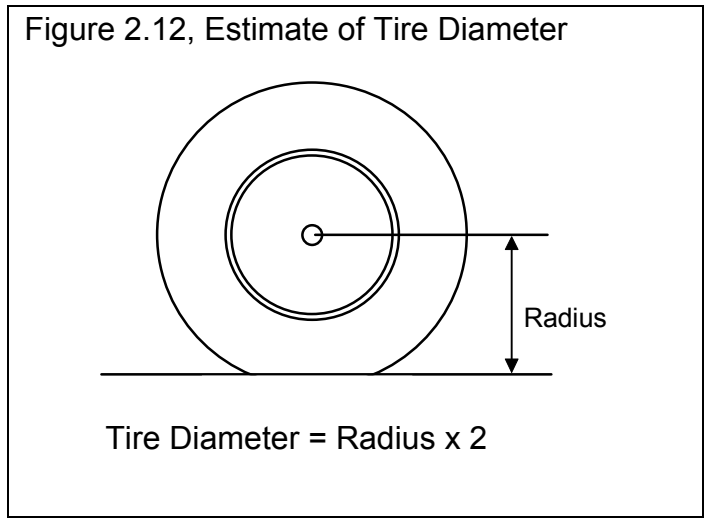

Since tires can squat as they are mounted on the car or as you change air pressure, a better estimate of the diameter is to measure the distance in inches from the center of the tire to the ground, while the tire is mounted on the car. This will give the radius, which you can then multiply by 2 to obtain your best estimate of the tire's diameter when mounted on the car.

Since Tire Diameter has a Clc button, see Section 2.8.5 for calculating Tire Diameter from other tire specs, like Rolling Radius, Circumference, or production tire sizes like P225-60-15.

Construction

The Construction type for the drive tire has a large effect on traction and therefore a large effect on the vehicle's maximum acceleration ability. Click on the down arrow of this combo box to be presented with a list of choices.

The Construction type and the following tire specs will determine the traction capability of the tires, and the amount of tire growth at high speed. If you select anything other than Drag Slicks, the Tire Growth specs is disabled as these other types of tires do not exhibit much growth.

Tread Width

Is the width of the tire's contact patch on the ground. Tread Width will only have a large effect on traction if you have specified Tire Type = Drag Slicks.

Traction Factor

Traction Efficiency describes how well the tires 'hook up' to the road surface. It is affected by road surface condition (concrete vs asphalt, amount of traction compound, etc.), tire conditions (temperature, pressure, compound, etc.) and suspension setup (4 link adjustments, shocks, etc.).

Obviously this spec has a critical impact on traction for all Tire Types. Because it depends on so many variables, it is difficult to estimate. You can click on the Clc button to obtain a general list of estimates. Most likely you will have to fine tune this estimate based on your vehicle's actual 60 ft times at a particular track. You can also use the Match Vehicle Performance option from the Main Menu to have the program estimate Traction Factor.

Table 2.3 gives estimates of Traction Factor for different road surfaces.

Tires behave quite differently on dirt or sand than concrete or asphalt, as assumed by the Drag Racing Analyzer. Therefore, it can not accurately predict acceleration performance of vehicles on dirt or sand.

Table 2.3 Estimate of Traction Factor

Type of Tire/Surface	Traction Factor
Dry Concrete with Traction Compound	95-105
Dry Concrete	80-95
Dry Asphalt	65-85
Wet Roads	30-50

Tire Growth, %

The Tire Growth specs is only used for Construction type of Drag Slicks, and is disabled for all other Construction types. The program's definition for Tire Growth is the percent the drive tire's radius (distance from center of wheel to the ground) will increase at 2000 wheel RPM with no additional aerodynamic down force or lift. Because this may be difficult to estimate, it is again suggested you use the Match Vehicle Performance option from the Main Menu to have the program estimate Tire Growth. You can also click on Examples to load in tires with estimated tire growths given, or click on the Clc button to pick from general categories of Growth.

2.6 Driving Specs

The Driving Specs describe how the driver controls gear changes, clutch release during the launch and power through the throttle.

After all specs are defined in this section below, a "Driving Specs Summary" section follows which describes how these options work together.

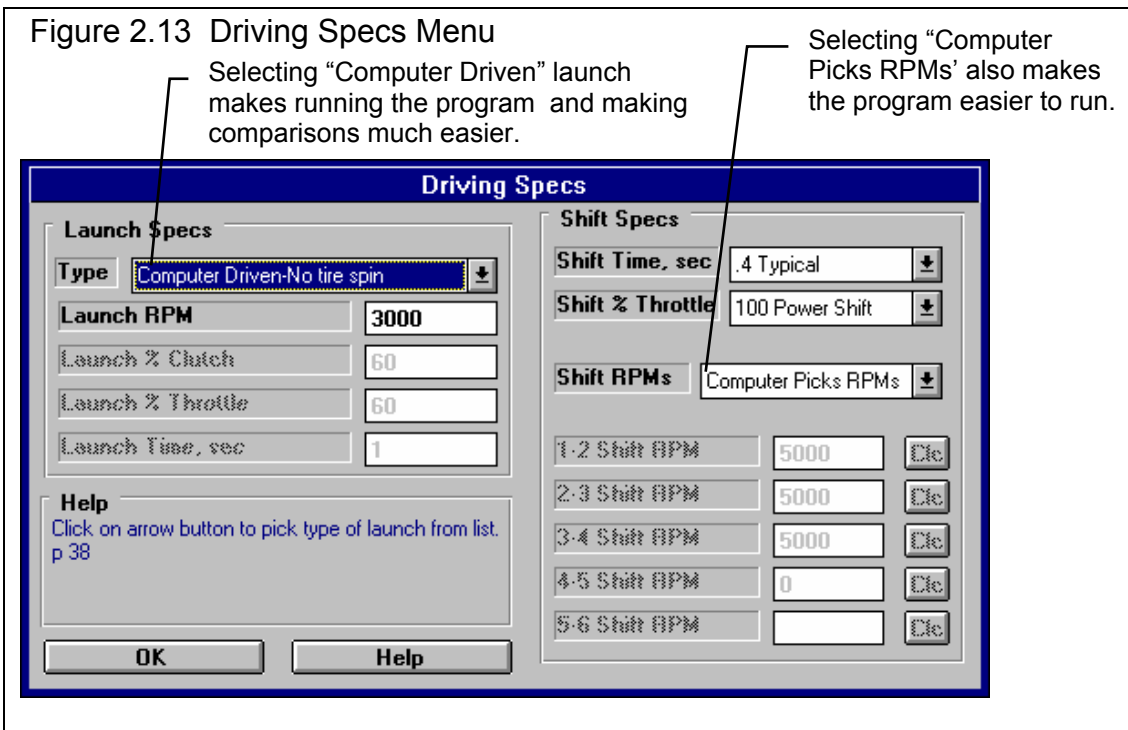

Launch Specs

The launch (getting the vehicle moving from its standing start) is probably the most critical element in drag racing. The Drag Racing Analyzer gives you several options for controlling engine power and clutch release during launch.

Type

Click on the down arrow button of this combo box to be presented with the following 3 choices:

- Computer Driven-No tire spin
- Use Specs Below (not available in Beginner Level, and quite difficult to work with)
- Clutch-Maintain Launch RPM-No tire spin (a second “computer driven” option, available for clutches only)

Depending on you choice of Type, some or all of the other Launch Specs will be enabled or disabled. These types are explained below.

Computer Driven-No tire spin

The computer will hold the engine at full power and "feather" the clutch to put the most power to the ground, but still prevent the tires from slipping. For transmissions with torque converters, the computer will hold the engine at full throttle and "feather" the drive axle's brakes to limit the power to the drive tires just enough to prevent tire spin. This is similar to current production "anti-spin" traction control. Selecting “Computer Driven-No tire spin” is the easiest way to launch the vehicle and make comparisons between vehicle modifications.

This Type of launch may not always give the best ET. For example, with very "sticky" tires and a clutch, the computer may release the clutch too quickly because the tires are not in danger of spinning. This may cause engine RPM to drop too much at the line, perhaps slightly "bogging" the engine, which can actually occur with the real vehicle. See the “Clutch-Maintain Launch RPM-No tire spin” option below.

Use Specs Below

The computer will drive exactly as specified by the other Launch Specs, which may allow the tires to "break loose" and spin. This Type useful for fine tuning your particular launch strategy, or to see how much the vehicle's E.T. suffers when the tires "break loose".

Clutch-Maintain Launch RPM-No tire spin

This is very similar to “Computer Driven-No tire spin” in that the computer will hold the engine at full power and "feather" the clutch to put the most power to the ground, but still prevent the tires from slipping. The difference is the computer will also **not** allow engine RPM to fall below Launch RPM, potentially eliminating engine bog. This option is only available if the transmission is using a clutch.

Launch RPM

Is the RPM at which the engine is held at the starting line before the clutch is released. This specification is ignored if the vehicle has a torque converter because the Converter Capacity spec and available engine torque will determine the "launch RPM" or stall RPM.

Launch % Clutch

Is the amount the clutch is "feathered" at the starting line at the beginning of the Launch Time. The program then increases this amount until it is at 100% at the end of the Launch Time. (This is a change from previous versions of Drag Racing Analyzer but seems to be more realistic.)

Launch % Clutch specifies how much of the total clutch force is allowed to grip the clutch disc (or put another way, how far the clutch pedal is released). For example, if the clutch is "dumped" or "side stepped" at the starting line with no feathering, this would be called 100% Launch % Clutch. If you release the clutch until it just starts to bring the engine RPM down, and you hold it there, that could be specified as 10% Launch % Clutch.

This specification is disabled if the vehicle has a torque converter or you are using a computer driven launch. This spec can also be used to simulate the hydraulic or pneumatic clutch management systems on funny cars or top fuel cars.

Launch % Throttle

This describes how far the throttle is opened during the Launch Time. The program then increases this amount until it is at 100% at the end of the Launch Time. (This is a change from previous versions of Drag Racing Analyzer but seems to be more realistic.)

If the throttle is immediately opened to wide open throttle (WOT), this would be specified as 100% Launch % Throttle. "Trans brake" vehicles where the throttle is WOT but the transmission output is locked would also use 100%. If the throttle is only opened to half throttle, this would be specified as 50% Launch % Throttle.

This specification is used for both clutch and torque converter transmissions, but is disabled if you are using a computer driven launch which eliminates tire spin.

Launch Time, sec

Is the amount of time the clutch and throttle are "feathered" at the start of the run until the Launch % Clutch and Launch % Throttle reach 100%. In other words, this is the amount of time the Launch % Clutch and the Launch % Throttle are in effect. After this amount of time, the clutch is released completely (100%) and the throttle is opened to WOT (wide open throttle or 100%).

This specification is disabled if you are using a computer driven launch.

Shift Specs

Shift Time, sec

Is the amount of time it takes the driver to shift. This is the total time starting from the moment the clutch is disengaged to when the clutch pedal is released after the shift. Click on the down arrow button of this combo box to select the time and description to best match your condition.

If the transmission has a torque converter, the program assumes this is the time required for the automatic transmission to shift. Smooth shifting, production automatics are designed to take more shift time than race automatics. See Driving Specs Summary at the end of this section.

Shift % Throttle

Is the amount of throttle given the engine during the shift process, in the same manner as specified under Launch % Throttle. If the Shift % Throttle is specified as 100%, the throttle is held at WOT during the shift and the engine will rev up between shifts. If the throttle is backed off between shifts (for example to 0% for the Shift % Throttle), the RPM will probably drop between shifts.

This specification is disabled if the vehicle is specified with a torque converter. The computer then assumes the throttle is held wide open (100% Shift % Throttle) during the shift.

Shift RPMs

Click on the down arrow key of this combo box to select to either have the program pick the shift RPMs (recommended to make program easier to use) or have the program Use Specs Below. If you select Use Specs Below, the Shift RPMs appropriate for the # of gears in the transmission become enabled.

1-2 Shift RPM

2-3 Shift RPM

3-4 Shift RPM

4-5 Shift RPM

5-6 Shift RPM

These are the RPMs at which the shifts take place. For example, the 1-2 Shift RPM specifies the engine RPM in first gear when the 1-2 shift starts.

Note: If the clutch is slipping when a shift RPM is reached, the computer will wait until both the engine *and* the clutch have reached the Shift RPM. Therefore, occasionally the engine RPM in the results will be higher than the RPM specified for the shift.

Because these specs have a Clc button, you can have the program calculate optimum shift RPMs and fill them in into these specs. See Section 2.8.7.

Driving Specs Summary:

To summarize the driving specifications, the sequence of events for a run for different cases is illustrated below:

Clutch, Launch Type: Computer Driven-No tire spin

Clutch, Launch Type: Clutch-Maintain Launch RPM-No tire spin

1. The engine is held at the Launch RPM.
2. At the start, the throttle is opened 100% and the clutch is "feathered" to give maximum power to the tires without letting them slip. If you selected to Maintain Launch RPM, engine RPM is not allowed to fall below Launch RPM.
3. When the engine and clutch RPM both reach the 1-2 Shift RPM, the clutch is disengaged, the throttle is opened as specified by the Shift % Throttle, the gears are changed from 1st to 2nd, and when time has passed as specified by the Shift Time, the throttle is opened 100% and the clutch is again "feathered" to give maximum power to the tires without "breaking them loose". If you selected to Maintain Launch RPM, engine RPM is not allowed to fall below Minimum Launch RPM.

- The third step is repeated for each transmission gear until the vehicle finishes the run. However, if you selected to Maintain Launch RPM, Engine RPM is allowed to fall below Launch RPM in all gears except 1st.

Figure 2.14 Clutch, Launch Type: Use Specs Below

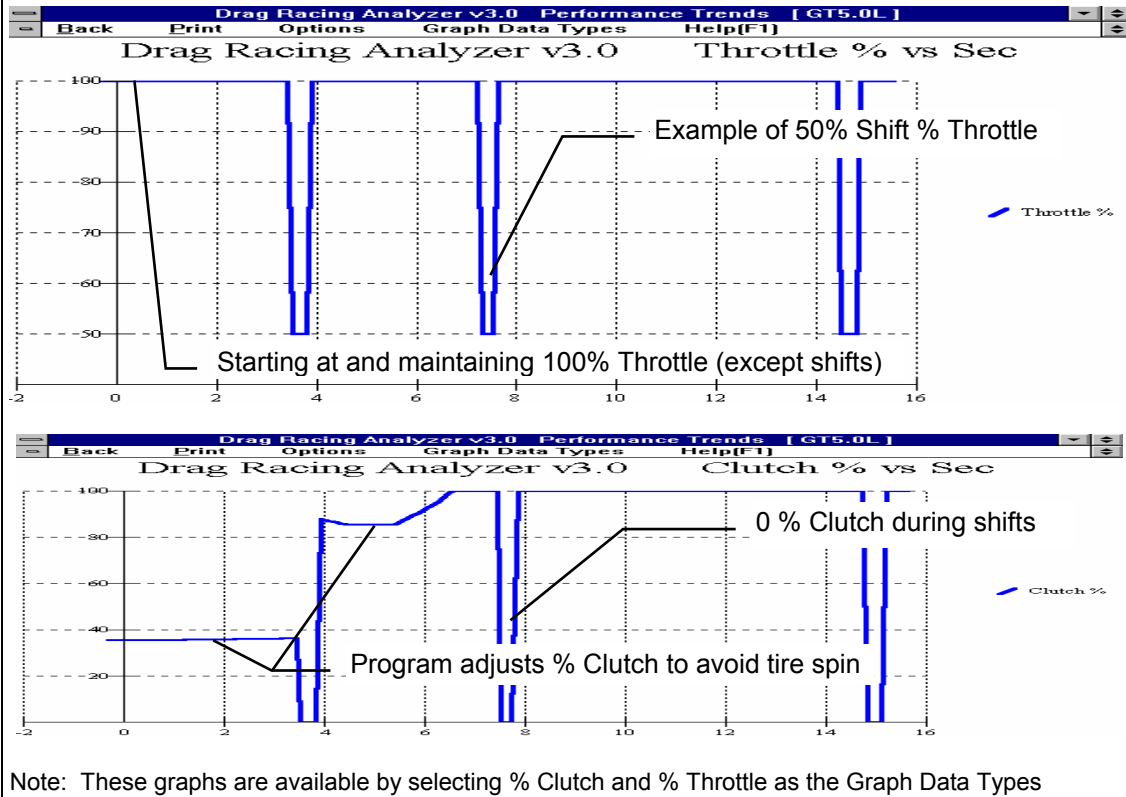

- The third step is repeated for each transmission gear until the vehicle finishes the run.

Notes:

The Launch Time starts the moment the clutch is released, not when the E.T. clock starts. For example, if the Launch Time was specified as 1.0 second and there was a .3 second rollout, the Launch Time would be over at .7 seconds on the E.T. clock.

If the first shift takes place before the Launch Time is over, the clutch and throttle are still controlled per the Launch Specs into Gear 2 until the Launch Time has run out.

Clutch, Launch Type: Use Specs Below

1. The engine is held at the Launch RPM.
2. At the start, the clutch is engaged as hard as specified by the Launch % Clutch and the throttle is opened as specified by the Launch % Throttle. The % Throttle and % Clutch are gradually increased from the starting percents so they are at 100% at the end of the Launch Time.
3. When the engine and clutch RPM both reach the 1-2 Shift RPM, the clutch is disengaged, the throttle is opened as specified by the Shift % Throttle, the gears are changed from 1st to 2nd, and when time has passed as specified by the Shift Time, the clutch is released 100% and the throttle is opened 100%.
4. The third step is repeated for each transmission gear until the vehicle finishes the run.

Notes:

The Launch Time starts the moment the clutch is released, not when the E.T. clock starts. For example, if the Launch Time was specified as 1.0 second and there was a .3 second rollout, the Launch Time would be over at .7 seconds on the E.T. clock.

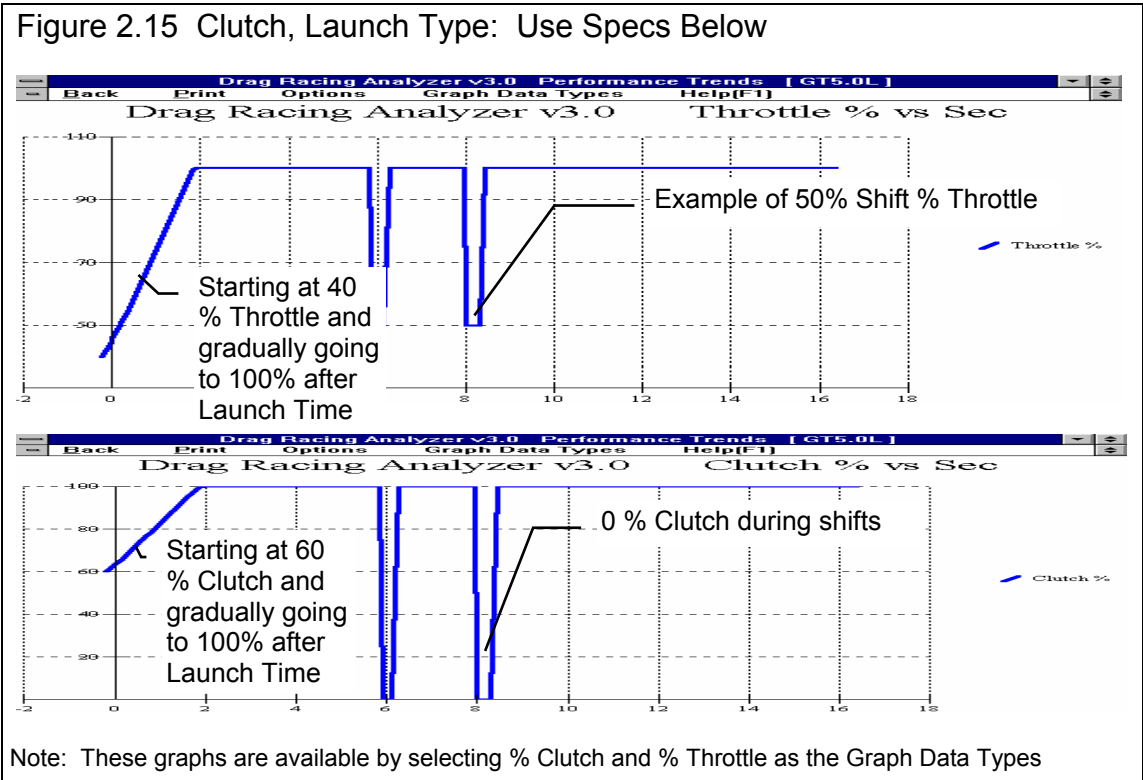

If the first shift takes place before the Launch Time is over, the clutch and throttle are still controlled per the Launch Specs into Gear 2 until the Launch Time has run out.

Torque Converter, Launch Type: Computer Driven-No tire spin

1. The engine is "brake torqued" at the converter's stall RPM. Stall RPM is determined by the engine's available torque and the Converter Capacity.
2. At the start, the brakes or trans brake are released and the throttle is maintained at 100%. The drive axle's brakes are then "feathered" as necessary to limit power to the driving tires to deliver maximum power to the tires, without "breaking them loose".
3. When the engine RPM reaches the 1-2 Shift RPM, the automatic shifts to 2nd. The engine RPM drops as much as is required for the next transmission gear. The throttle remains open 100% during the shift and the drive axle's brakes are again "feathered" as required to put maximum power to the tires without allowing tire spin.
4. The third step is repeated for each transmission gear until the vehicle finishes the run.

Note:

This method of launching will give the best possible E.T. and MPH in most cases for the given vehicle description and driving specs with a torque converter.

Figure 2.16 Converter, Launch Type: Computer Driven-No tire spin

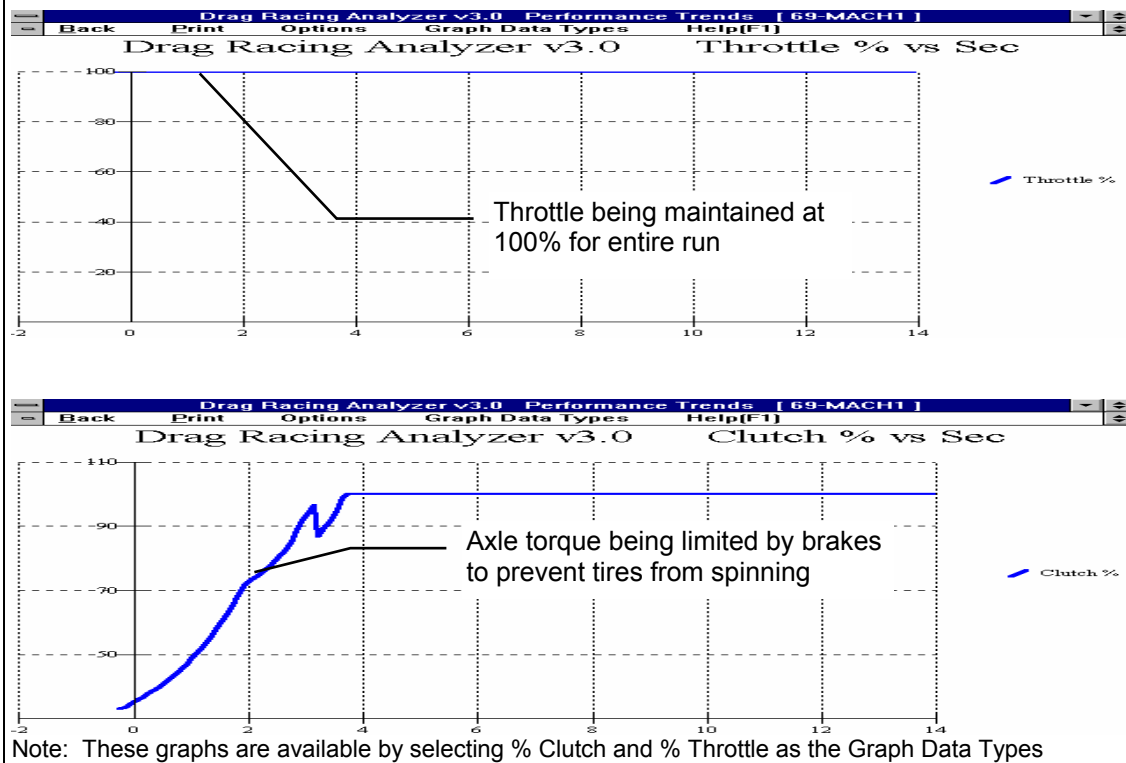

Note: These graphs are available by selecting % Clutch and % Throttle as the Graph Data Types

Torque Converter, Launch Type: Use Specs Below

1. The engine is "brake torqued" at the converter's stall RPM. Stall RPM is determined by the engine's available torque (as limited by Launch % Throttle) and the Converter Capacity.
2. At the start, the brakes are released and the throttle is opened as specified by the Launch % Throttle. The % Throttle is gradually increased from the starting percents so it is at 100% at the end of the Launch Time.
3. When the engine RPM reaches the 1-2 Shift RPM, the automatic shifts to 2nd. The engine RPM drops as much as required for the next transmission gear. The throttle remains open 100% during the shift.
4. The third step is repeated for each transmission gear until the vehicle finishes the run.

Figure 2.17 Converter, Launch Type: Use Specs Below

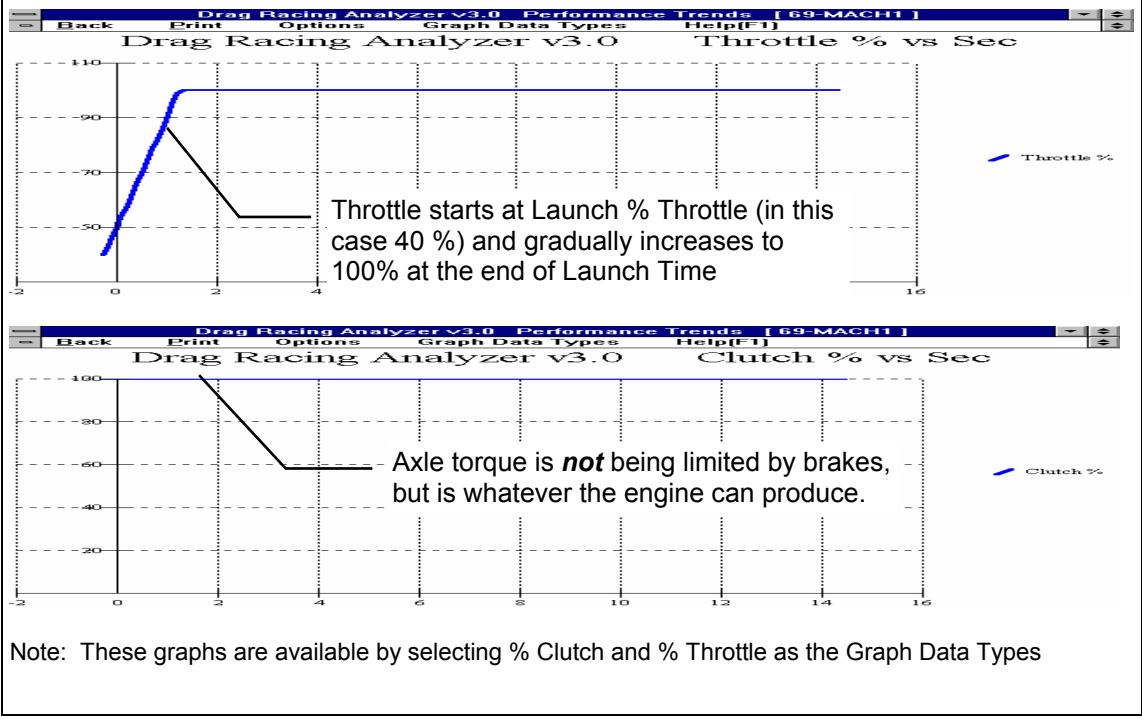

Notes:

The Launch Time starts when the brakes are released, not when the E.T. clock starts. For example, if the Launch Time was specified as 1.0 second and there was a .3 second rollout, the Launch Time would be over at .7 seconds on the E.T. clock.

If the first shift takes place before the Launch Time is over, the throttle is still "feathered into Gear 2 until the Launch Time has run out.

For automatic transmission shifts, the Drag Racing Analyzer uses Shift Time to define how quickly the valve body can perform shifts. During a shift, engine RPM drops and energy is released from this drop in engine RPM. The program increases driveshaft torque to approximately simulate recovering the engine's and converter's inertia energy. Inertia energy is the energy released when the engine and converter spinning at a high RPM before the shift are slowed down to a lower RPM after the shift. This inertia energy is responsible for the vehicle's "jump forward" during shifts, possibly spinning the tires. The shorter the Shift Time, the "harsher" the shift and the greater the driveshaft torque from recovering inertia energy.

2.7 Calculate Performance

2.7.1 Calculate Performance Conditions

At the Main Menu, you can calculate performance by:

1. Clicking on Calculate Performance to open the Calculate Performance Conditions menu, then clicking on Calculate Performance.
2. Clicking on the Calc ET button at the top of the Main Menu.
3. Pressing the <F2> key from anywhere in the Main Menu.

If you click on Calculate Performance, you will first be presented with a menu of conditions which describe how you will "run" this vehicle. These conditions include:

- Weather and wind conditions
- Total track length
- How you "stage" your vehicle with respect to the "staging lights"

Figure 2.18 Calculate Performance Menu

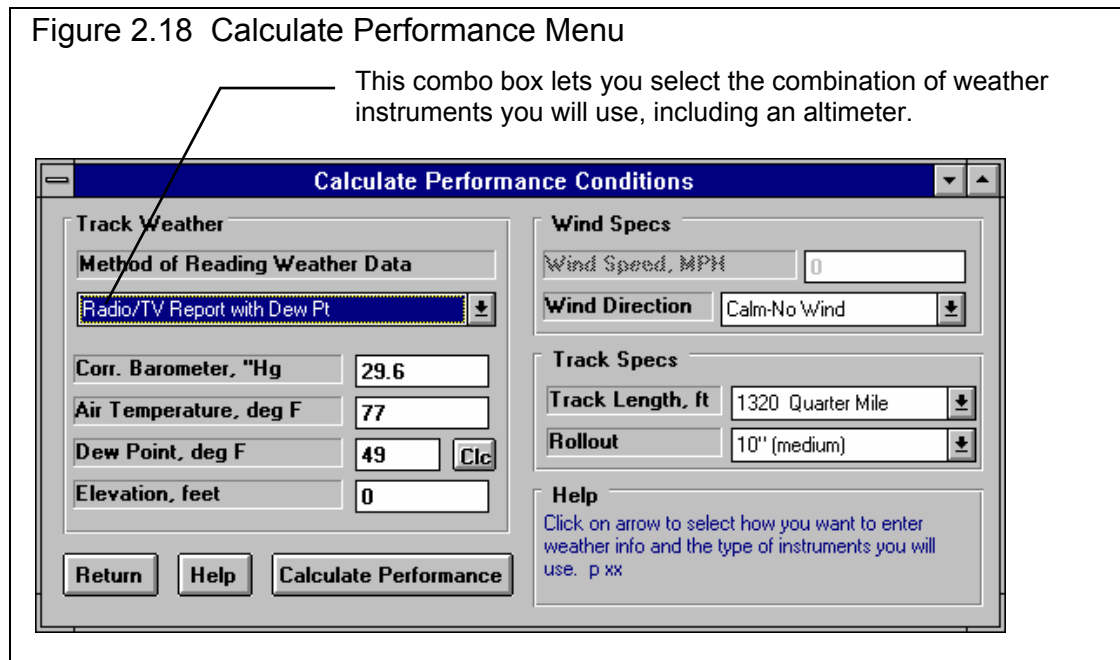

Track Weather

The weather conditions affect both the air's oxygen density which affects engine power, and the air's total density which affects aerodynamic drag. Many drag racers use their own personal "weather stations". In these cases, be sure you read the Notes on Weather Conditions at the end of this section., page 52.

Method of Recording Weather Data

Click on the down arrow button of this combo box to be presented with this list of options:

- Radio/TV Report with Rel Hum
- Radio/TV Report with Dew Pt
- Uncorr. Baro with Rel Hum
- Uncorr. Baro with Dew Pt
- Altimeter with Rel Hum
- Altimeter with Dew Pt

If you change the Method, the 4 inputs specs in the Weather section are changed or enabled/disabled as necessary to represent the new Method. In addition, all the input specs are adjusted to what they would be with the new Method. For example, Corr. Barometer of 29.3" at an elevation of 1200 feet is converted to 28.03" Obs Barometer with Elevation disabled. (Elevation is not important when you are using an uncorrected or observed barometer, as this type of barometer shows the actual air pressure at the track.)

If you change from "Uncorr Baro" to Radio/TV Report with a "Corr. Baro", the program will ask for an Elevation for the track, since this is needed to make the Barometer Correction. All these different inputs are explained below.

Barometric Pressure

Corr. Barometer, "Hg

This input is used for either "Radio/TV Report with Rel Hum" or "Radio/TV Report with Dew Pt". It is the Corrected Barometric Pressure in inches of Mercury you will hear from most any TV or radio weather report. This spec is disabled if you are using an Altimeter, because the altimeter alone is measuring the air pressure.

Obs. Barometer, "Hg

This input is used for either “Uncorr. Baro with Rel Hum” or “Uncorr. Baro with Dew Pt”. It is the actual or observed Barometric Pressure in inches of Mercury at the track. These barometers measure the actual air pressure at the track, and will read *approximately* .1 inches of mercury less than the barometric pressure you will hear from a TV or radio weather report for each 100 feet of elevation. This spec is disabled if you are using an Altimeter, because the altimeter alone is measuring the air pressure.

Air Temperature

Air Temperature deg F

Air temperature in degrees F of the air at the track. This spec is used for all Methods of Recording Weather Data.

Humidity

Relative Humidity, %

Describes the air’s humidity level in percent of humidity the air could hold at its present temperature. Relative Humidity can be calculated from either wet and dry bulb temperatures, or from dew point and air temperature readings by clicking on the Clc button. See Section 2.8.9.

Dew Point, deg F

The dew point in degrees F of the air at the track, which describes the air's humidity level. The Dew Point, deg F must be less than the Air Temperature. Dew Point can be calculated from either wet and dry bulb temperatures, or from relative humidity and air temperature readings by clicking on the Clc button. See Section 2.8.8.

Dew Point is a less confusing way of describing the air's moisture level than relative humidity. Relative humidity readings are only meaningful if the air temperature when the reading was made is also known. However, the air's dew point remains constant even when the air temperature changes. For example, 40 degree air with a 80 % relative humidity has only a 10% relative humidity when the same air is heated to 100 degrees. However, the dew point remains at 36 degrees for both air temperatures.

Elevation

Elevation, ft

The elevation of the track above sea level in feet. This spec is only used if you are using a Corrected Barometer, like from a TV or radio station weather report. If the elevation is below sea level, enter a negative (-) feet for this reading.

Altimeter

The altitude in feet above sea level from an altimeter instrument. The program assumes the altimeter is corrected to 29.92". This means on a standard 29.92" barometric pressure, 60 deg day, the altimeter would read 0 feet at sea level. If the altimeter is reading feet below sea level, enter a negative (-) feet for this reading.

Notes on Weather Readings and Weather Stations

Many racers will use "weather stations", a collection of temperature, humidity and barometric pressure measuring devices. When using these instruments, here are some things to keep in mind:

- Unless you are very close to sea level, an actual (observed or uncorrected) barometer will usually read less than a TV or radio weather report barometer. For elevations less than 5000 feet, an uncorrected barometer should read *approximately* 0.1 " Mercury less for each 100 feet of elevation above sea level. For example, if your barometer instrument is at 850 feet elevation and the closest weather station reports 30.46" barometric pressure, your barometer should read *approximately* .85" (850/100 x .1) less, or 30.46-.85= 29.61. It is useful to keep records of information like this (what your actual barometer reads versus what this simple calculation says it should approximately read) to see if the comparison is constantly jumping around. If you always make the check at the same place (same elevation) like your home or shop, and the difference is varying high by .1", than low by .2", etc., you may want to have the barometer or altimeter checked out.
- If you find that you are making many adjustments to your weather station, you are probably doing something wrong. A barometer or altimeter which reads low, but *consistently* reads low is better for predicting throttle stop or dial in trends, than one you are trying to keep accurate by constantly adjusting. it.
- Unless you are racing in *very* different air (at least 1000 ft different in dry density altitude), you are probably better off not changing jets. Unless you know if you were on the rich side or lean side to start with, you may actually be making things worse. Also, constant carb adjustments are just one more thing to go wrong and cause inconsistency.

Wind Specs

Wind Speed, MPH

The wind speed in MPH. Wind speed has a significant effect on ET and accurate measurements are difficult to come by. You may want to invest in a hand held anemometer or vane wind speed indicator.

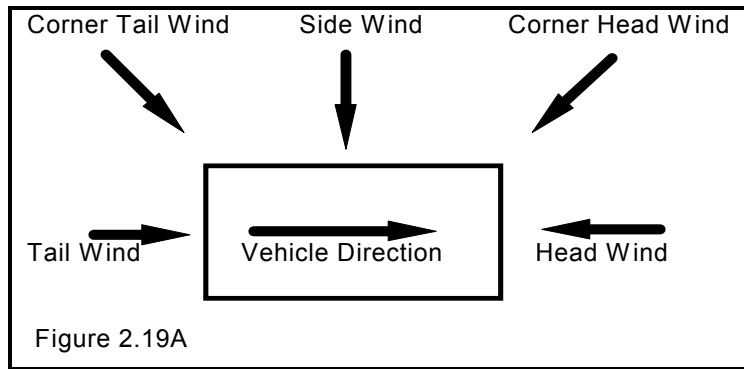

Wind Direction

Click on this combo box to select from the following wind directions. Also see Figure 2.19A.

- Calm-No Wind
- Head Wind
- Tail Wind
- Side Wind
- Corner Head Wind
- Corner Tail Wind

Track Specs

Track Length, ft

Click on this combo box to select from the following track lengths:

- 1320 Quarter Mile
- 660 Eighth Mile
- 5280 One Mile
- 7040 El Mirage (1.33 mi)
- 26400 Bonneville (5 mi)

If you select 1320 ft, the program also gives the MPH reading in the summary at the top as based on the 2 lights separated by 66 ft, just as official drag strips. You will notice this MPH is slightly less than that listed in the results at 1320 ft.

If you enter 7040 ft (the distance of El Mirage) or 26400 ft (the distance of Bonneville) you get readings at the standard distances for timing reports at these tracks. Also, as you increase distance, the time increments of the plots gets larger, and the results get reported at larger distance intervals. In the History Log, the 60 ft time is replaced by 1/8 mile time for 5280 and 7040, and by 2 mile time for 26400.

Rollout, in

Click on this combo box to select from the following rollout distances:

- 6" (deep)
- 10" (medium)
- 14" (shallow/short)
- 0" (like data logger)

Rollout is the distance traveled by the vehicle during the process of uncovering the lights to start the ET timer during drag racing. This distance is generally 4-12 inches and is affected by tire size, how the vehicle is "staged", timer light positions, etc.

Rollout, in can be measured by measuring how far your vehicle travels from the following 2 points:

1. When the "staged" light first comes on, assuming that is how you "stage" your car.
2. When the "staged" light goes off (or whatever else starts the ET timer) from rolling forward through the beams. At most tracks, uncovering the "staged" light beam is what starts the ET timer.

Although a few inches appears to be a minor detail, the rollout can affect the ET up to a couple tenths of a second. If you want data reported where the timer starts the moment the vehicle starts accelerating (like accelerometer or fifth wheel instruments), enter a rollout distance of 0.

2.7.2 Calculate Performance Test Results

The Drag Racing Analyzer's calculated output is shown in Figure 2.19B below.

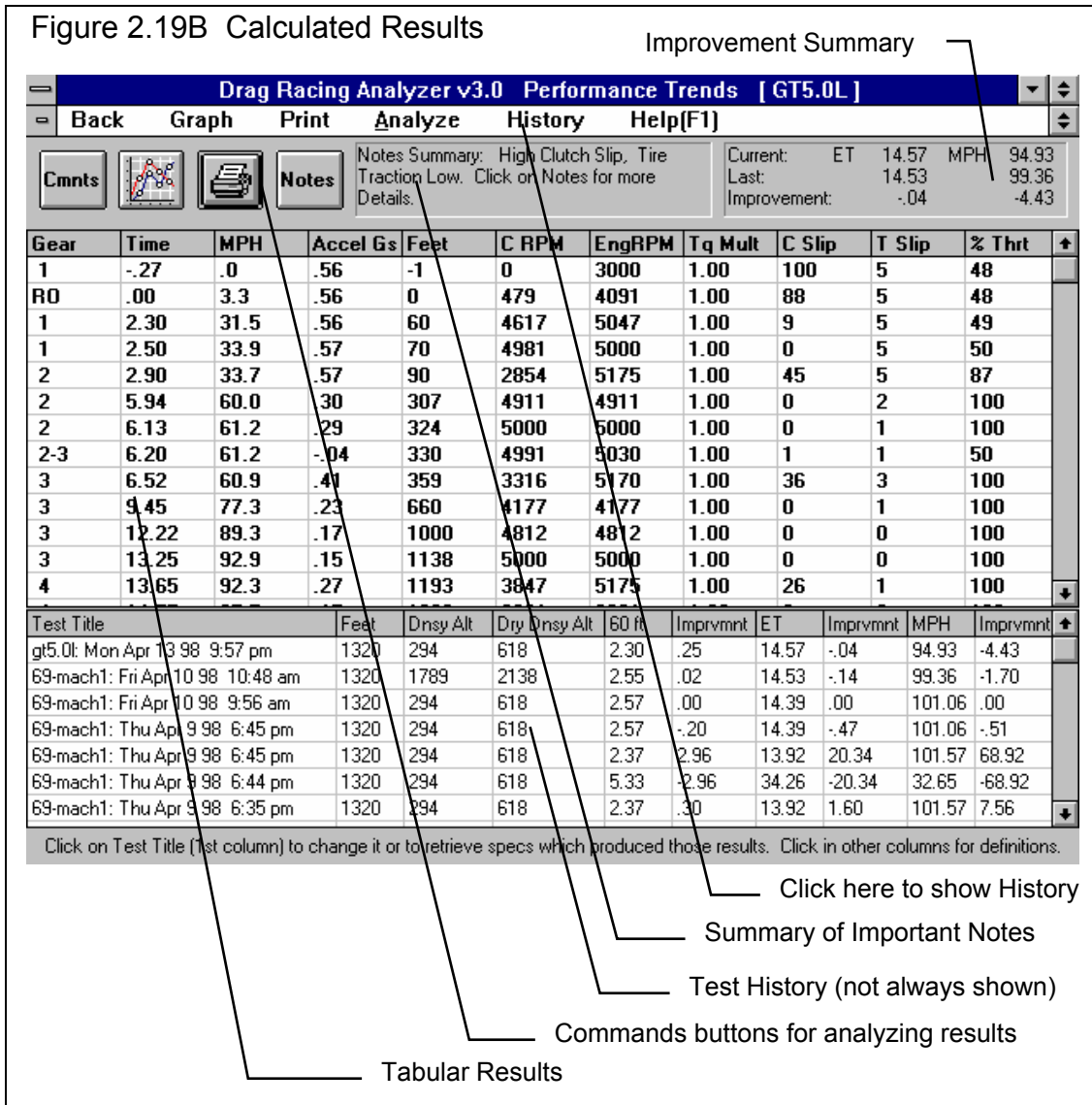

Improvement Summary

The Improvement Summary section compares the final results of the current run with those of the previous run. This saves you from writing down ETs and MPHs to see how much effect a given modification has on performance.

ET (Elapsed Time in Seconds)

Is the time from when the vehicle's front tires uncover the "staged" light beam until the front tire breaks the finish line light beam at the end of the track. Different tracks may have different locations and calculations regarding these light beams. These differences may have some effect on the Rollout time but should have nearly no effect on ET.

If you have selected .001 second increments in the Preferences menu at the Main Menu, ET will be reported in thousandths of a second.

MPH (Final Velocity in Miles per Hour)

Is the vehicle's velocity at the end of the run in miles per hour.

If you have selected 1320 Quarter Mile as the Track Length, the MPH will be the average velocity for the last 66 ft of the run. This MPH closely simulates standard drag strip MPH, which is based on the time it takes the vehicle to break a light beam 66 ft before the finish line, and the finish light beam at 1320 ft. You will notice that this MPH is somewhat less than the MPH reported at 1320 ft in the tabular results. For any other distance, MPH is the vehicle's speed exactly as it crosses the finish line.

Improvement

Improvement is simply the difference between the Current Run and the Last Run for which performance was calculated.

If the improvement is a positive value:

- The Current Run's ET was quicker (shorter) than the Last Run's
- The Current Run's MPH was faster (greater) than the Last Run's

Tabular Results

The tabular results gives important vehicle and engine information at significant points during the run:

- At the start of the run.
- When the Rollout distance has been traveled (when the staged light is uncovered).
- At the beginning and end of each shift.
- At 60, 330, 660 and 1000 ft (Some tracks also give times for these distances.)
- At 60 and 100 MPH.

Occasionally, two of these conditions may occur very close together. For example 60 MPH may occur a couple hundredths of a second before the start of the 1-2 shift at 5000 RPM. In these cases, you may only get one reading, either the 60 MPH point or the start of the shift at 5000 RPM.

In these cases there may also be some slight error in reporting the results. For example, if the 60 MPH point was reported, it may show engine RPM at 5047 for the start of the 1-2 shift, not the specified 5000 RPM. These errors produce insignificant errors in the overall MPH and ET. These discrepancies are reduced if .001 second time in the Preferences menu .

The following section defines each data column:

Gear

Is the transmission Gear # currently being used. An "RO" indicates the "rollout" condition, where the vehicle has moved the distance defined by Rollout..

If data is reported during a shift, both gear numbers are given. For example, the 60 Feet point may show a Gear of "1-2", which indicates 60 feet occurred during the 1-2 shift.

Sec

Shows the elapsed time since the Rollout distance was traveled. If Rollout is specified as 0, this column shows the time since the vehicle first started to accelerate. Negative values of Sec shows these conditions occurred before the Rollout distance was traveled. For example, if the first Sec value is -.22 and the second value is 0 (Gear = RO), it says the vehicle started the acceleration .22 seconds before the rollout condition was met, which starts the ET timer.

If you want the timer to start the instant the vehicle starts to accelerate (not like a drag strip ET timer), select Rollout of 0 (like data logger).

The resolution of the time column can be increased to thousandths of a second by selecting .001 second increments in the Preferences menu

MPH

Is the vehicle's velocity in MPH.

Accel Gs

Is the vehicle's acceleration in Gs. If the tires are spinning, the G value is followed by an S.

Feet

Is the distance the vehicle has traveled during the run, measured in feet.

C RPM

Is the clutch or converter output RPM. See EngRPM.

EngRPM

Is the engine RPM. The difference between CRPM and EngRPM is the amount the clutch or converter is slipping. If the clutch is not slipping, CRPM will be equal to EngRPM.

TqMult

The amount of torque multiplication which is produced in the torque converter or clutch. A value of 1.5 indicates that the output of the torque converter is 1.5 times as large as the torque which entered it. If the engine can output 300 ft-lbs, the torque converter will increase it to 450 ft-lbs. See torque converter explanation in the Assumptions, Appendix 1.

If the vehicle is equipped with a clutch, this value is 1.

C Slip

Is the amount of clutch or converter slip occurring, in percent.

T Slip

Is the amount of slip in the tires, in percent. All tires show some slip during acceleration, even if they do not "break loose". If the tires are slipping excessively ("broken loose"), T Slip% is shown as 100% and an "S" appears in the Accel Gs column.

% Thrt

Is the percent of the engine's HP being allowed to be delivered to the clutch or converter. This will be reduced from 100% to prevent tire spin, as directed by the Launch % Throttle, or as directed by the Shift % Throttle.

2.8 Calculation Menus:

The following section explains the user input for engine specs listed with Clc buttons. These specs are ones where you can simply enter a value, or click on the Clc button and the program will present a menu of inputs which will calculate that particular parameter. These menus are like computer “scratch pads” for calculating specs like Final Drive Ratio, Tire Diameter, etc. from other inputs.

Notes:

The starting values in each calculation menu are usually blanked out when the menu is opened. If there is other information in the program to estimate what one of your input values will be, it may be loaded. As shown in Figure 2.20, Vehicle Weight, Engine Cubic Inches and RPM at HP Peak are already available from other menus in the program, and these values are loaded into the Calculation Menu. You are free to change them to any other value.

Once enough specs have been entered, the calculated value(s) at the top of the menu will be displayed. This calculated value(s) will now be updated each time you change a spec. If you want to use this calculated value, click on Use Calc Value. If the calculated value is within expected limits, it will be loaded into the original menu. If you click on Cancel, you will be returned to the original menu with the original value unchanged. If you click on Help, you will be given a general explanation of calculation menus, and a page # in this section for more info about the particular menu you are using.

The input values or calculated values in any calculation menu have NO affect on calculated performance unless you load the Calculated value into the original menu. ***If you already know a spec in the form required by the program, then you have no need to use the calculation menu.*** For example, if you know the engine makes 420 ft lbs at 4500 and 450 HP at 6000 RPM, then, you have no need to use a calculation menu to calculate Peak Tq and Peak HP.

Figure 2.20 Typical Calculation Menu

Parameter	Value
Peak HP	461.0
Peak Torque, ft lbs	475.0
Peak Torque RPM	4200
Vehicle Weight, lbs	3200
Quarter Mile MPH	121
Engine Cubic Inches	302
RPM at HP Peak	5600

Notes:
This calculation will produce approximate power curve specs based on very simple inputs. It always uses the 'Std Dyno' Corr Factor. The 'Match Veh Performance' option is a more exact way to build a power curve based on more vehicle & performance specs.

Example

Assume you want to calculate Peak Torque and Peak Horsepower for your car, but you know very little about the engine. You could click on one of the Clc buttons by Peak Torque or Peak Horsepower in the Engine Specs menu. You will be presented with the menu shown in Figure 2.20.

Vehicle Weight, Engine Cubic Inches and RPM at HP Peak are already available from other menus in the program, and these values are already loaded into the Calculation Menu. Vehicle Weight and Cubic Inches are accurate for your engine and vehicle so you leave them “as is”. However, RPM at HP Peak you are not sure of and you may change this.

Note that all inputs are disabled except Type of Calc. Select the Type of Calc from this Combo box. Since you do know your quarter mile MPH, select Quarter Mile MPH.

All specs except Vol Eff are now enabled (printed in black, not gray). All you have to do is enter your Quarter Mile MPH of 121 and press <Enter>. You now see the calculated Peak HP, Peak Torque and Peak Torque RPM at the top of the menu.

You would be ready to Use Calc Values if the RPM at Peak HP was correct. From reading in this section, you see that a good estimate of RPM at Peak HP is about 500 RPM less than the RPM you shift at or go through the traps at. So you decide to adjust that up to 5500 RPM. You see Peak HP stay the same but Peak Torque and Peak Torque RPM updated to new, more accurate readings.

If you click on Cancel, you will return to the Engine Specs menu with the Power Curve specs unchanged. If you click on Use Calc Value, you will be returned to the Engine Specs menu with the Calculated Peak HP, Peak Torque, Peak HP RPM and Peak Torque RPM filled in.

2.8.1 Calc Power Curve

This calculation is available from the Engine specs menu and lets you estimate a set of engine Power Curve specs. Initiate this calculation by entering a Clc button for any engine Power Curve spec or the Calculate button if you are using a Full Power Curve, for this menu.

Peak HP
Peak Torque, ft lbs
Peak Torque RPM

Are the values calculate from these inputs.

If you select Quarter Mile or Eighth Mile MPH as the Type of Calc, Peak HP is calculated from a simple equation relating only vehicle weight and finish MPH to available HP. Note that these Engine Power Curve specs may *not* give the same performance (quarter mile or eighth mile MPH) when coupled with your particular vehicle specifications.

If you select CID and Vol Eff, the Peak HP value is calculated using the following assumptions:

- 85% mechanical efficiency at RPM at HP Peak
- 35% thermal efficiency
- Gasoline as the fuel with an energy content of 19,000 BTU/lb
- Dry air density of .0764 lbs/cu ft

The other Power Curve specs are derived from Peak HP and RPM at HP Peak and an assumed shape of the torque curve based on the Cubic Inches. The RPM at HP Peak input at the bottom of the menu is always loaded back into the Engine specs menu.

These calculations are based on power corrected to the standard aftermarket dyno correction factor of 29.92" mercury and 60 degrees dry air. Therefore, anytime you use values from this menu, the Corr Factor in the Engine menu will be set to Std Dyno (29.92 and 60 deg)

Figure 2.21 Calc Power Curve

Field	Value
Peak HP	461.0
Peak Torque, ft lbs	475.0
Peak Torque RPM	4200
Performance Specs	
Type of Calc	Quarter Mile MPH
Vehicle Weight, lbs	3200
Quarter Mile MPH	121
Engine Cubic Inches	302
Vol Eff	
RPM at HP Peak	5600

Notes:
This calculation will produce approximate power curve specs based on very simple inputs. It always uses the 'Std Dyno' Corr Factor. The 'Match Veh Performance' option is a more exact way to build a power curve based on more vehicle & performance specs.

Use Calc Value Help Cancel

Type of Calc

Click on this combo box to select from:

- Quarter Mile MPH
- Eighth Mile MPH
- CID and Vol Eff

Depending on your choice certain inputs will now be enabled.

Vehicle Weight, lbs

Is the vehicle's total weight including driver, in pounds. This is initially set to the Vehicle Weight in the Body & Axle menu, but can be changed to anything you want.

Quarter Mile MPH Eighth Mile MPH

Is the vehicle's top speed in a standing start, quarter mile or eighth mile acceleration.

Engine Cubic Inches

Is the engine's size in Cubic Inches. This is initially set to the Displacement in the Engine menu, but can be changed to anything you want.

Vol Eff

Is the engine's volumetric efficiency at the HP peak. Volumetric efficiency means what is the amount of air which this engine pulls in one cycle compared to how much it could under "ideal" conditions. Generally this is less than 100%, but can be up to 130% for highly tuned race engines, or up to 300% on supercharged or turbocharged engines. Generally, this is not the engine's peak volumetric efficiency (which usually occurs at the torque peak) but is close to it.

Click on the down arrow of this combo box to select from the following choices:

- 65 Bad Production
- 75 Typ Production
- 80 Good Production

- 85 HiPerf Production
- 90 Poor Street/Strip
- 95 Typ Street/Strip
- 100 Good Street/Strip
- 110 Good Race Engine
- 115 Very Good Race Engine
- 120 Excellent Race Engine
- 125 Pro Stock/Formula 1
- 90 Prod, 5 PSI Boost
- 100 Prod, 10 PSI Boost
- 110 Prod, 15 PSI Boost
- 120 Prod, 20 PSI Boost
- 95 HiPrf Prod, 5 PSI Boost
- 110 HiPrf Prod, 10 PSI Boost
- 125 HiPrf Prod, 15 PSI Boost
- 135 HiPrf Prod, 20 PSI Boost
- 105 Strt/Strp, 5 PSI Boost
- 120 Strt/Strp, 10 PSI Boost
- 135 Strt/Strp, 15 PSI Boost
- 145 Strt/Strp, 20 PSI Boost
- 115 Good Race, 5 PSI Boost
- 130 Good Race, 10 PSI Boost
- 145 Good Race, 15 PSI Boost
- 160 Good Race, 20 PSI Boost
- 140 Exc Race, 10 PSI Boost
- 170 Exc Race, 20 PSI Boost
- 200 Exc Race, 30 PSI Boost
- 225 Exc Race, 40 PSI Boost
- 250 Exc Race, 50 PSI Boost
- 270 Exc Race, 60 PSI Boost
- 285 Exc Race, 70 PSI Boost
- 300 Exc Race, 80 PSI Boost

RPM at HP Peak

Is the RPM at which the HP peak occurs. This is initially set to the RPM at HP Peak in the Engine menu, but can be changed to anything you want.

Note: Most any modification which increases HP (other than nitrous oxide or super/turbocharging) will also increase RPM at HP Peak. If you have no information about your RPM at HP Peak, use an RPM 500 RPM lower than your shift RPM. This RPM input is always loaded back into the Engine specs menu.

2.8.2 Calc Final Drive Ratio

This menu is available by clicking on the Final Drive Ratio Calc button in the Body & Axle specs menu.

Type

Click on this combo box to select from:

- Ring & Pinion Gear Only (typical of most rear wheel drive rear axles)
- Chain Drive Only (typical of go carts, most motorcycles, etc.)
- Gear Reduction & Chain Drive (typical of motorcycles where there is a chain reduction between the engine and the transmission, and then there is the chain ratio between the transmission and rear axle)

Depending on your choice certain inputs will now be enabled.

Teeth, Pinion Gear

This is the number of teeth on the smaller pinion gear (or drive gear which attaches to the driveshaft) in the rear axle. If you selected Gear Reduction & Chain Drive as the Type, this is the # teeth on the sprocket or drive gear on the engine's crankshaft. In almost all cases, this number will be smaller than # Teeth Ring Gear.

Teeth, Ring Gear

This is the number of teeth on the larger ring gear (or driven gear which attaches to the axle shafts through the differential) in the rear axle. If you selected Gear Reduction & Chain Drive as the Type, this is the # teeth on the sprocket or drive gear on the transmission input shaft or clutch shaft. In almost all cases, this number will be larger than # Teeth Pinion Gear.

Figure 2.22 Calc Final Drive Ratio

Calc Final Drive Ratio

Calc Final Drive Ratio 3.08

Inputs

Type Ring & Pinion Gear Only

Teeth, Pinion Gear 13

Teeth, Ring Gear 40

X Teeth, Drive Sprocket

X Teeth, Wheel Sprocket

Note:
For motorcycles with a gear drive between the engine and transmission, select 'Gear Reduction & Chain Drive' as the Type.

Use Calc Value Help Cancel

Teeth, Drive Sprocket

This is the number of teeth on the smaller drive sprocket on the engine or transmission for chain drive systems. In almost all cases, this number will be smaller than # Teeth Wheel Sprocket.

Teeth, Wheel Sprocket

This is the number of teeth on the larger driven sprocket on the wheel or axle for chain drive systems. In almost all cases, this number will be larger than # Teeth Drive Sprocket.

2.8.3 Calc % Wt on Rear Tires

This calculation is available from the Body & Axle Specs menu and allows you to calculate a vehicle's weight distribution.

Total Vehicle Weight, lbs

Is the total vehicle weight with driver as measured on a scale. This initially set to the Vehicle Weight in the Body and Axle specs menu, but can be changed to anything.



Weight on 1 Axle

Is the weight recorded on the scale with the driver when only one axle's tires are on the scale, either front or rear tires.

Which Axle?

Click on the combo box to choose either Rear or Front, to identify which axle was on the scale for the Weight on 1 Axle measurement.

2.8.4 Calc Frontal Area

This calculation is available from the Body & Axle Specs menu and allows you to estimate a vehicle's frontal area.

Track Width, inches

Is the distance from the center of one front tire to the center of the other front tire. This value is initially set to the Rear Track Width in the Body and Axle specs menu, but can be changed to most anything you want.

Roof Height, inches

The distance in inches from the ground to highest portion of the roof or vehicle in inches which extends nearly the full width of the vehicle.

Figure 2.24 Calc Frontal Area

Calc Frontal Area, sq ft	
Calc Frontal Area, sq ft	19.79
Vehicle Dimensions	
Track Width, inches	57
Roof Height, inches	50
Note: This calculation is only an approximation of Frontal Area, based on 2 easily obtained measurements. For most situations (MPH less than 150) Frontal Area will not have a large effect on performance and this approximation is	
Use Calc Value	Help
Cancel	

For example, for a truck with a roll bar behind the cab, measure to the top of the roll bar, but not to the top of one of the spot lights mounted on the bar. However, if so many lights are mounted on the bar that

they are nearly continuous for the full width of the vehicle, it may be more accurate to then measure to the top of the spot lights.

2.8.5 Tire Diameter Tread Width

This calculation is available from the Wheel & Tire Specs menu and allows you to estimate either a front or rear wheel's Tire Diameter and Tread Width for certain Tire Rating Types.

Note: For all Rating Types except Rolling Radius, the Calc Tire Diameter is approximately 3% less than what you would calculate based on the exact dimensions. This is to allow for some tire wear, deformation, and slip.

Rating Type

Click on this combo box for the following rating types:

- P-Metric (ex P225-60-15)
- Letter (ex G-60-15)
- Rolling Radius, inches
- Circumference, inches

Depending on your choice, certain specs will become enabled. If you choose the P-Metric or Letter Type, you will also be able to calculate the Tread Width.

Figure 2.25 Calc Tire Diameter

Calc Tire Diameter, inches

Calc Tire Diameter, inches: 24.1

Calc Tread Width, inches: 7.7

Inputs

Rating Type: P-Metric (ex P225-60-15)

Metric Tire Size (ex 225): 225

Letter Tire Size: []

Aspect Ratio: 50

Wheel Rim Diameter, in: 16

Rolling Radius, in: []

Circumference, in: []

Note:
Calculated diameters are reduced approximately 3% from exact dimensions to allow for some wear, deformation and slip.

Use Calc Value Help Cancel

Metric Tire Size (ex 225)

Identifies the tire's cross sectional width in millimeters and is also related to the tire's load carrying capacity.

Letter Tire Size

Identifies the tire's load carrying capacity. Click on this combo box to select on of the letters. This is an older rating system and there is more variation across manufacturer's.

Aspect Ratio

Is the ratio of tire cross sectional height to cross sectional width. A 75 series tire has a height 75% as high as its cross sectional width, and is generally a tall tire. A 50 series tire is a lower profile tire, more suited to cornering and performance.

Wheel Rim Diameter

Is the diameter of the wheel's rim.

Rolling Radius, in

Is the tire's radius, measured with the tire mounted on the car, with the tire on the ground with typical vehicle weight on it. Radius is the distance from the center of the tire to the ground. See Figure 2.26 ***Note that this is the only calculation where the diameter is not reduced by 3%, because the load is already deforming the tire. This is usually the most accurate way to Calculate the Tire Diameter.***

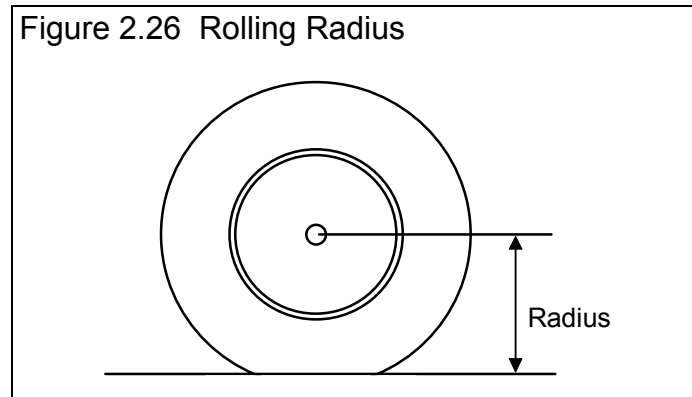

Circumference, in

Is the tire's circumference measured in inches. Circumference is the distance around the outside of the tire on the tread.

2.8.6 Estimated Traction Factors

This Calculation menu is available by clicking on the Traction Factor Clc button in the Wheel/Tire menu. Click on the combo box to be presented with the following choices:

- 110 Best Possible Suspension Setup & Track
- 100 Best Drag Strip with Traction Compound
- 95 Good Drag Strip with Traction Compound
- 90 Tire on Good Concrete
- 85 Tire on Average Concrete
- 80 Tire on Good Asphalt
- 75 Tire on Average Asphalt

This menu is different than other Calculation menus in that there is not calculation performed, but you are simply picking a Traction Factor from a list of descriptions.

The Traction Factors in this list are very general. You will probably have to fine tune this spec based on your vehicle's actual 60 ft times. The program can also determine Traction Factor with the Match Vehicle Performance command at the Main Menu.

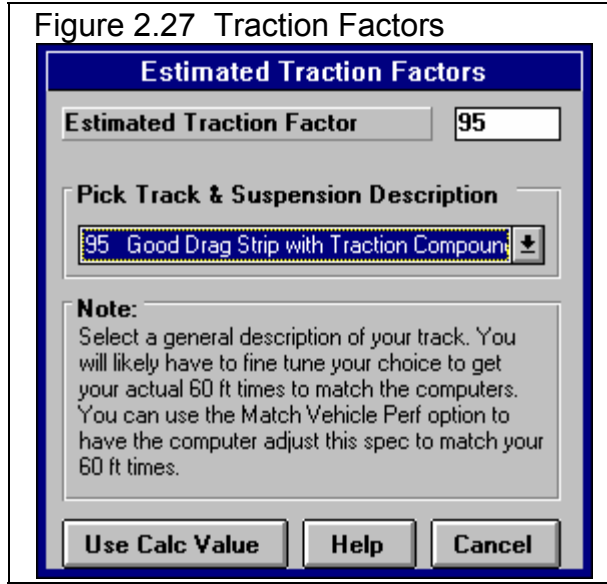

2.8.7 Calculated Shift RPMs

This Calculation menu is available by clicking on the Shift RPMs Clc button in the Driving Specs menu. There are no inputs to this menu. You are simply telling the program to calculate what it would use for Shift RPMs. As Figure 2.28 shows, you can then choose to use (load in) these Calculated Shift RPMs.

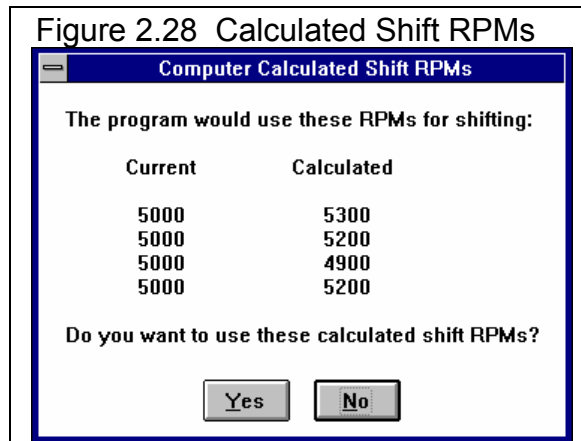

2.8.8 Calc Dew Point, deg F

Depending on your choice of Method of Recording Weather Data, you will be entering either Dew Point or Relative Humidity in the Calculate Performance Conditions menu or in the Throttle Stop or Dial In menus. These humidity inputs at all these menus have a Calc button. This is the Calculation Menu you will get if you are using Dew Point.

Know Relative Humidity?

If you know the relative humidity of the air and the air temperature, select Yes. Otherwise select No to input Wet and Dry bulb temperatures from a psychrometer. Depending on your choice the appropriate inputs are enabled.

Figure 2.29 Calc Dew Point

Calc Dew Point, deg F	
Calc Dew Point	65.2
Weather Inputs	
Know Relative Humidity ?	Yes ↓
Outside Air Temp, deg F	77
Outside Rel Humidity, %	68
Dry Bulb Temp, deg F	77
Wet Bulb Temp, deg F	
Use Calc Value	Help
Cancel	

Outside Air Temp, deg F

Is the outside air temperature when the relative humidity measurement was made. For example, if the weather service or weather report gives a relative humidity of 56 % and a temperature of 68 degrees, use 68 degrees.

Outside Rel Humidity, %

Is the air's relative humidity as reported by a weather service or measured by humidity instruments.

Dry Bulb Temp, deg F

Is the temperature of the dry bulb thermometer on the psychrometer in degrees F. This is also the temperature of any thermometer mounted in the shade when the Wet Bulb Temp reading is taken. The Dry Bulb Temp must not be less than the Wet Bulb Temp.

Wet Bulb Temp, deg F

Is the temperature of the wet bulb thermometer on the psychrometer in degrees F. The wet bulb has a "wick" or cloth covering the bulb which is moistened with water. The dryer the air, the greater the difference between the wet and dry bulb readings. Relative humidity or dew point can be manually read off a Psychrometric chart from these two readings. This calculation replaces reading the chart. The Wet Bulb Temp must be less than the Dry Bulb Temp.

2.8.9 Relative Humidity, %

Depending on your choice of Method of Recording Weather Data, you will be entering either Dew Point or Relative Humidity in the Calculate Performance Conditions menu or in the Throttle Stop or Dial In menus. These humidity inputs at all these menus have a Calc button. This is the Calculation Menu you will get if you are using Relative Humidity.

Know Dew Point?

If you know the dew point of the air and the air temperature, select Yes. Otherwise select No to input Wet and Dry bulb temperatures from a psychrometer. Depending on your choice the appropriate inputs are enabled.

Figure 2.30 Calc Relative Humidity

Calc Relative Humidity, %	
Calc Relative Humidity	53.0
Weather Inputs	
Know Dew Point ?	No
Outside Air Temp, deg F	77
Dew Point, deg F	
Dry Bulb Temp, deg F	77
Wet Bulb Temp, deg F	65
Use Calc Value	Help
	Cancel

Outside Air Temp, deg F

Is the outside air temperature when the Dew Point measurement was made.

Dew Point, deg F

Is the air's Dew Point in degrees F as reported by a weather service or measured by humidity instruments.

Dry Bulb Temp, deg F

Is the temperature of the dry bulb thermometer on the psychrometer in degrees F. This is also the temperature of any thermometer mounted in the shade when the Wet Bulb Temp reading is taken. The Dry Bulb Temp must not be less than the Wet Bulb Temp.

Wet Bulb Temp, deg F

Is the temperature of the wet bulb thermometer on the psychrometer in degrees F. The wet bulb has a "wick" or cloth covering the bulb which is moistened with water. The dryer the air, the greater the difference between the wet and dry bulb readings. Relative humidity or dew point can be manually read off a Psychrometric chart from these two readings. This calculation replaces reading the chart. The Wet Bulb Temp must be less than the Dry Bulb Temp.

2.9 Match Vehicle Performance

The Drag Racing Analyzer will automatically 'fine tune' certain critical specs to match a particular vehicle's performance. See Example 4.2. The Match Vehicle Performance process consists of:

1. You set all specs to match the vehicle you are building as close as practical. ***This is very important for accurate results.***
2. Click on the Match Veh Perf button at the top of the Main Menu to bring up the Match Vehicle Performance menu shown in Figure 2.31.
3. Fill in the Match Vehicle Performance menu with the vehicle's performance. Then click on OK (adjust veh. specs to match performance) to start the process.
4. The program will adjust:
 - Engine Power Curve
 - Torque Converter Capacity or will switch the clutch specs to "Let Program Estimate Clutch Specs" if the clutch is too small for the Engine Power Curve.
 - Tire Traction Factor
 - Tire Construction, if it needs more traction than 110% Traction Factor can provide
 - Tire Growth
 - Tire DiameterTo find a combination giving the closest match to the vehicle's performance.

If the program can not arrive at acceptable specs in 100 passes down the track, it will give you a notice. You may then want to double check your entries in the Match Veh Perf menu or some of the other specs in the other menus.

If the program does arrive at acceptable specs, you will be shown a summary of the new specs the program found and how close the program matched performance, as shown in Figure 2.32. You can then load these specs into the menus for this vehicle.

This process can save a good deal of "cut and try" on your part to get your vehicle

Figure 2.31 Match Veh Perf Menu

Your Vehicle's Actual Performance	
Distance of Race	Quarter Mile
Start RPM at Launch	3000
60 Foot Time, sec	1.8
Finish MPH	127
Finish Engine RPM	5500
Finish Trans Gear #	4

Tip: If you are not sure of 'Finish Engine RPM' or do not want tire diameter changed, just leave it blank or set it to 0. The program will not adjust tire growth or diameter to match this RPM.

Help
Click on down arrow button to select either Quarter or Eighth Mile run. p xx

Help Cancel Clear Entries

OK (adjust veh. specs to match performance)

specs adjusted. Example 4.2 shows the Match Vehicle Performance process in more detail.

Distance of Race

Select either Quarter or Eighth mile for the distance of the race you are trying to match.

Stall RPM at Launch

Enter the converter's stall RPM during the launch. Stall RPM is the highest RPM you see on the tach or data logger with the throttle wide open but the back tires not turning. This occurs with the trans brake ON, or before the car has had a chance to move off the line.

This spec is not enabled if the Transmission Specs indicate a clutch is being used.

60 foot time

The vehicle's 60 ft time from the track's timer.

Finish MPH

The vehicle's MPH at the end of the run (either eighth or quarter mile). This is sometimes called "trap speed" or speed through the "traps".

Figure 2.32 Results of Match Veh Perf

Modifications Required to Match your Performance

Performance from New Specs

	60 ft	MPH	RPM	Gr
Specified Vehicle Perf	1.8	127	5500	4
Perf Obtained from New Specs	1.81	126.3	5366	4

Specs Which Have Been Changed

Spec Name	Old	New
Engine Pk Tq	270.0	598.5
Engine Pk HP	210.0	466.0
Eng Pk HP RPM	4400	5369
Clutch Specs	User Specs	Estimate
Rear Tire Diameter	24.9	21.00
Tire Construction Type	Drag Slick	Drag Slick
Tire Traction Factor	90	103.19
Tire Growth	10	8.51

Keep These New Specs **Return to Old Specs**

Finish Engine RPM

The engine's RPM at the end of the run, or at the same time when Finish MPH is recorded. If you are not sure of this RPM, or you do not want the Tire Diameter adjusted, leave this spec blank or set it to zero.

Finish Trans Gear

The transmission gear at the end of the run, or at the same time when Finish MPH is recorded.

2.10 Throttle Stop Prediction

A throttle stop is a throttle activator which closes the throttle a certain amount for a programmed amount of time a programmed amount of time after the clutch switch or trans brake switch is activated at the start of the run. Many Super Class racers use throttle stops to control their car's performance to run their index ET. Couple all the settings available for the throttle stop and weather and wind variations, consistently running the Index ET is complicated. See **Example 4.4**.

The Drag Racing Analyzer's Throttle Stop Prediction screen will help you decide how to adjust your throttle stop timer for winning consistency. Click on the Throttle Stop button at the top of the Main Menu and you are presented with the menu shown in Figure 2.33. This menu will let you predict the throttle stop setting (usually the time the stop is ON or the throttles are closed) required to produce some desired ET (usually the Index) based on 2 previous runs with different throttle stop settings. Important points for accuracy include:

- It is important for accuracy that most all the other vehicle specs accurately match your vehicle before you use the 'Throttle Stop' option. This means that if you Calculate Performance for these specs, you will get an ET within about .3 seconds and a MPH within about 2 MPH of what your car runs with No throttle stop.
- These 2 throttle stop settings should be significantly different, ideally 1 producing a faster ET and 1 producing a slower ET than your desired ET.
- The prediction can still work even though both ETs are faster or slower than your desired ET, as long as there is significant difference (at least .3 seconds or more) in the 2 ETs which is not caused simply by the weather change.
- The accuracy of the predicted Throttle Stop also depends on the Time Resolution setting in the Preferences menu available at the Main Menu (.001 seconds gives better accuracy).
- All 3 runs should use the same weather instruments for all measurements (without calibration or adjustment in between).
- Although you may not want to change your strategy, predictions are best if the throttle stop comes on after the 60 foot timing lights.

In this menu you can enter:

- Your vehicle's actual 60 ft time and ET for 2 previous runs.
- The weather and wind conditions which produced these results.
- Your vehicle's throttle stop setting for these 2 runs.
- Your desired ET for the third run or Index to Run.
- The weather and wind conditions for the third run where you want to run the Index.
- Optional: Your prediction of the 60 foot time for the Predicted run.

When all these have been entered, click on 'Update Throttle Stop' or the Clc button by Throttle Stop. The program will make 3 passes simulating the 2 runs you have already made and the 3rd run you want to predict. Based on these results, the program will calculate the throttle stop setting to produce the desired ET for the third run or 'Index to Run'.

Figure 2.33 Throttle Stop Menu

Weather and ET for 2 previous runs with significant difference in throttle stop settings.

Menu bar of commands to open or save a file of Throttle Stop specs, copy specs from 1 run to another, update the prediction, etc.

Weather conditions for Throttle Stop prediction to run the Index ET.

Current Vehicle file. This must be the vehicle these Throttle Stop Specs are for.

Previous Run		Run 1	Run 2
Corr. Baro., "Hg		29	29.07
Air Temp, deg F		88	77
Dew Point, deg F		65 <input type="button" value="Clc"/>	63 <input type="button" value="Clc"/>
Elevation, feet		670	670
Wind MPH		11	9
Wind Direction		Side Wind <input type="button" value="v"/>	Side Wind <input type="button" value="v"/>
Throttle Stop		.75	1.95
60 foot, sec		1.405	1.401
ET, sec		9.76	10.12

Predicted Run	
Corr. Baro., "Hg	29.13
Air Temp, deg F	75
Dew Point, deg F	63 <input type="button" value="Clc"/>
Elevation, feet	670
Wind MPH	7
Wind Direction	Side Wind <input type="button" value="v"/>
Estimate Change in 60 Foot Time	
Let Program Estimate 60 ft time <input type="button" value="v"/>	
60 foot, sec	1.405
Throttle Stop	1.38 <input type="button" value="Clc"/>

General Specs and Comments	
Method of Reading Weather Data	Index, sec
Radio/TV Report with Dew Pt <input type="button" value="v"/>	9.9
Example of Throttle Stop inputs. These specs were obtained from the <input type="button" value="v"/>	T/S Start Time
	2.5

Help
 Barometer reading in inches of mercury. CORRECTED to sea level for elevation. p xx

Comments you can enter to describe data. These are useful reminders when you open a saved Throttle Stop File.

Type of weather instruments you are using.

Index ET or the ET you want to run plus any safety margin.

The Throttle Stop setting the program recommends to run the Index.

This menu is almost like a separate program, because you can enter comments in the lower left corner to describe what these specs represent. You can then Save these specs by clicking on File in the Menu Bar, then Save or Save As. Save As lets you save these specs under a new name, where Save simply updates the current name with any changes.

By saving sets of specs, you can predict throttle stops in the future when you do not have results from 2 previous runs. Simply click on File, then Open, and pick a Throttle Stop file with weather conditions or track conditions fairly similar to those you will be running. Again, be sure the current vehicle specs match your vehicle you are running.

IMPORTANT: This method of using a past, saved Throttle Stop file is not nearly as accurate as using previous runs from the same track, same day and same weather instruments.

See Section 3.3 for how to Open or Save vehicle files. Saving or Opening Throttle Stop files work much the same way.

There are 2 general sets of commands which let you copy sets of data from 1 run to another. These are:

- The Edit command where you can Copy or Clear various runs.
- The Advance command where you move runs from right to left, as you would when your Predicted run now becomes your Previous Run #2 on which you will predict a new run.
Remember, Previous Run #1 and the new Previous Run #2 should have at least .3 seconds difference in ET.

2.10.2 Definition of Inputs

Weather Inputs

Corr. Barometer, "Hg

Obs. Barometer, "Hg

Air Temperature deg F

Relative Humidity, %

Dew Point, deg F

Elevation, ft Altimeter

Method of Recording Weather Data

These are all explained in Section 2.7.1, starting on page 50. All 3 runs must use the same Method of Recording Weather Data. That is because the same weather instruments should be used for all measurements for the best accuracy.

Throttle Stop (Previous Runs)

Is the throttle stop setting (usually the time the throttle stop is on, or is closing the throttles) in seconds. This is the adjustment you usually have the greatest control over and which gives the best consistency.

60 foot, sec (Previous Runs)

Is the 60 foot times for the previous runs.

ET, sec

Is the ET you obtained for the 2 previous runs with the different throttle stop settings. It is best if one of these runs is faster and one is slower than the Index, and the difference in ET is at least .3 seconds.

Estimate Change in 60 Foot Time

Click on this combo box for 2 choices:

- Let Program Estimate 60 ft time
- You Enter (predict) 60 Foot Time Below

If you let the program estimate the 60 ft time, it will assume nearly the same traction as Previous Run #2. If you want to enter your prediction of 60 ft time, based on lane choice, traction change through the day, etc., select You Enter (predict) 60 Foot Time Below. Then the 60 foot, sec input will be enabled where you can enter your own estimate.

60 foot, sec (Predicted Run)

Is your estimate of the 60 foot time for the Predicted Run. See Estimate Change in 60 Foot Time above.

Index, sec

Is the Index, or your desired ET. In the Super Classes there are usually 8.90, 9.90 or 10.90 seconds. You may want to build in your own safety factor, one which may change depending on the situation. Say if you feel confident of a win (novice opponent), you may want to enter 9.92, for a 20 thousandths second safety margin, be sure you don't break out. We recommend you always use some safety margin, at least .005 seconds.

T/S Start Time

In this version, this time is only used to ensure the 60 foot times are not being affected by the throttle stop. If the program thinks the throttle stop is On before the 60 foot time, 60 foot times are not used in the prediction.

Throttle Stop (Predicted Run)

This is the program's prediction of your throttle stop setting to run the Index ET. If this is blank, click on the Clc button by it or Update Prediction in the menu bar at the top of the menu. The Throttle Stop is not saved, because its value will change depending on what the other vehicle specs in the program are set to.

Check Appendix 3 for new Throttle Stop options added to v3.2.

2.11 Dial In Prediction

The Dial In Prediction menu will let you predict the ET of a future run based on a past run and the weather conditions of the past run and the future run. This is very useful for predicting 'Dial In' for bracket racing.

Click on the Dial In button at the top of the Main Menu and you are presented with the menu shown in Figure 2.34. This menu will let you predict the ET of a future Predicted Run with different weather, wind, and possibly traction conditions based on 1 previous run. Important points for accuracy include:

- It is important for accuracy that most all the other vehicle specs accurately match your vehicle before you use the 'Dial In' option. This means that if you Calculate Performance for these specs, you will get an ET within about .3 seconds and a MPH within about 2 MPH of what your car actually runs.
- The accuracy of the predicted Dial In also depends on the Time Resolution setting in the Preferences menu available at the Main Menu (.001 seconds gives better accuracy and Dial In prediction to the nearest .001 seconds).
- Both runs should use the same weather instruments for all measurements (without calibration or adjustment in between).

In this menu you can enter:

- Your vehicle's actual 60 ft time and ET for the Previous run.
- The weather and wind conditions which produced these results for the Previous run.
- The weather and wind conditions for the future Predicted run.
- Optional: Your prediction of the 60 foot time for the Predicted run.

When all these have been entered, click on 'Update Dial In' or the Clc button by Dial In. The program will make 2 passes simulating the Previous run you have already made and the future run you want to predict. Based on these results, the program will calculate expected ET or Dial In setting. You may want to add a safety margin to this, say .010 seconds or so, to prevent breaking out (running faster than your Dial In).

Figure 2.34 Dial In Menu

Weather and ET for previous run.

Menu bar of commands to open or save a file of Dial In specs, copy specs from 1 run to another, update the prediction, etc.

Weather conditions for Dial In prediction to run the Index ET.

Current Vehicle file. This must be the vehicle these Dial In Specs are for.

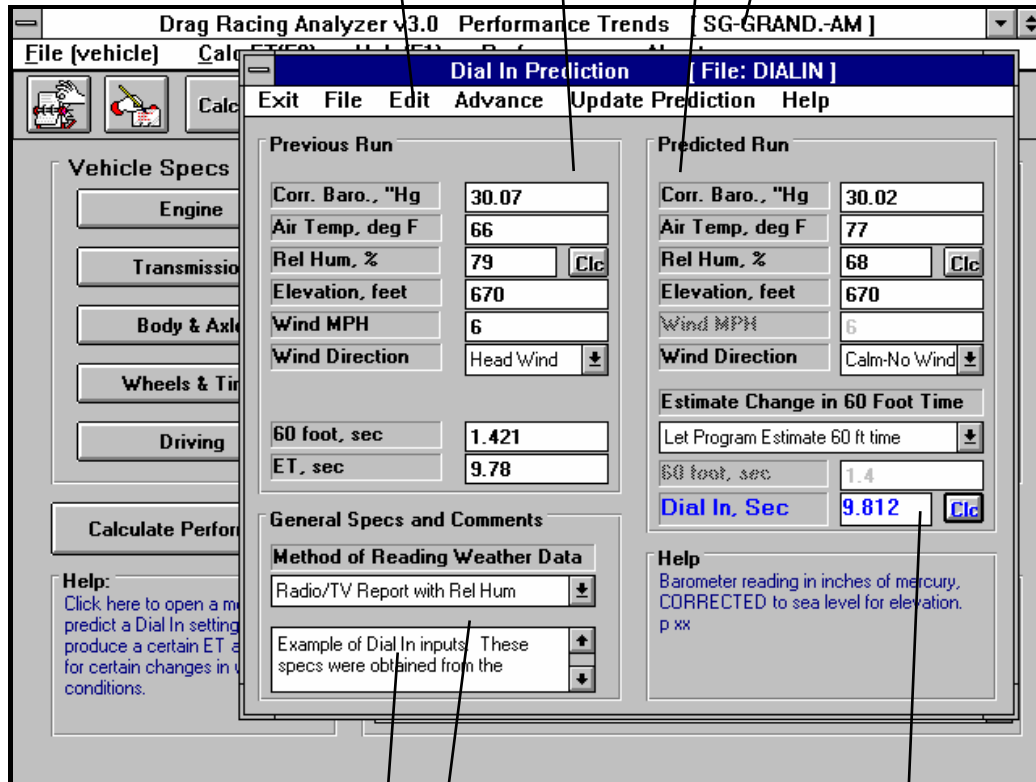

Comments you can enter to describe data. These are useful reminders when you open a saved Dial In File.

Type of weather instruments you are using.

The Dial In the program recommends (the ET the program expects you to run). Remember to subtract off any safety margin you may need for your actual Dial In to run.

This menu is almost like a separate program, because you can enter comments in the lower left corner to describe what these specs represent. You can then Save these specs by clicking on File in the Menu Bar, then Save or Save As. Save As lets you save these specs under a new name, where Save simply updates the current name with any changes.

By saving sets of specs, you can predict Dial Ins in the future when you do not have results from a previous run. Simply click on File, then Open, and pick a Dial In file with weather conditions or track conditions fairly similar to those you will be running. Again, be sure the current vehicle specs match the vehicle you are running.

IMPORTANT: This method of using a past, saved Dial In file is not nearly as accurate as using the previous run from the same track, same day and same weather instruments.

See Section 3.3 for how to Open or Save vehicle files. Saving or Opening Dial In files work much the same way.

There are 2 general sets of commands which let you copy sets of data from 1 run to another. These are:

- The Edit command where you can Copy or Clear various runs.
- The Advance command where you move runs from right to left, as you would when your Predicted run now becomes your Previous Run on which you will predict a new run.

2.11.2 Definition of Inputs

Weather Inputs

Corr. Barometer, "Hg

Obs. Barometer, "Hg

Air Temperature deg F

Relative Humidity, %

Dew Point, deg F

Elevation, ft

Altimeter

Method of Recording Weather Data

These are all explained in Section 2.7.1, starting on page 50. All 3 runs must use the same Method of Recording Weather Data. That is because the same exact instruments should be used for all measurements for the best accuracy.

60 foot, sec (Previous Runs)

Is the 60 foot times for the previous run for your car at the track.

ET, sec

Is the ET you obtained for the previous run for your car at the track.

Estimate Change in 60 Foot Time

Click on this combo box for 2 choices:

- Let Program Estimate 60 ft time
- You Enter (predict) 60 Foot Time Below

If you let the program estimate the 60 ft time, it will assume nearly the same traction as the Previous Run. If you want to enter your prediction of 60 ft time, based on lane choice, traction change through the day, etc., select You Enter (predict) 60 Foot Time Below. Then the 60 foot, sec input will be enabled where you can enter your own estimate.

60 foot, sec (Predicted Run)

Is your estimate of the 60 foot time for the Predicted Run. See Estimate Change in 60 Foot Time above.

Dial In (Predicted Run)

This is the program's prediction of your Dial In setting to run the Index ET. If this is blank, click on the Clc button by it or Update Prediction in the menu bar at the top of the menu. The Dial In is not saved, because its value will change depending on what the other vehicle specs in the program are set to.

You will have decide if you want to use this predicted Dial In "as is" or ***subtract off a safety factor*** of say .010-.020 seconds or so. The more you subtract off the Dial In, the less likely you are to "break out" (run faster than your Dial In and be disqualified). For example, if you are up against a novice opponent and the program is predicting a 9.655 Dial In, you may want to use a 9.635 (9.655-.020) Dial In. This gives you a .020 second cushion or safety margin to prevent "breaking out".

2.12 Examples

Many of the specs which the Drag Racing Analyzer uses to predict performance are difficult for some users to get. For that reason, the program comes with sets of Example specs which the user can load in automatically and easily.

Figure 2.35 Using Component Examples

If you are currently using a set of Example specs, the name of the Example will appear here. You can also click on this combo box to pick a new example or switch the Type to Use Specs Below.

Should you decide to change any of the Example's specs (from Driveline Layout to Drag Coefficient), the name will be changed to simply Use Specs Below.

Click on the Get Example button (or on the Type combo box and select Pick an Example) to bring up a list of example specs.

Click here to save the current specs as an Example with a name of your choosing. (Not available is current specs are already an Example.)

At the top of most component sections of the Drag Racing Analyzer’s menus, you will find a description of the “Type” of component used. In Figure 2.35 the component section is the Body Details in the Body & Axle menu. This combo box can 2 or 3 choices:

- Use Specs Below
- Pick An Example
- Ex Body: 65-68 Mustang Big Block (or some other name of a specific example)

Figure 2.35 shows that the current Body Details specs are those picked from the Drag Racing Analyzer’s Example specs for a 65-68 Big Block Mustang. This name can be a handy reminder of the type of vehicle you are simulating, and also where you got these specs.

There are 2 general ways to pick an example component. You can either select the Pick An Example from the Type combo box or click on the Get Example button at the bottom of the menu. You may be first presented with a list of general categories of component examples, like shown in Figure 2.36. (This screen would not appear for picking Body Details because there is no other component examples available at this menu.)

Figure 2.36 Categories of Example Components (This screen does not appear for all component examples.)

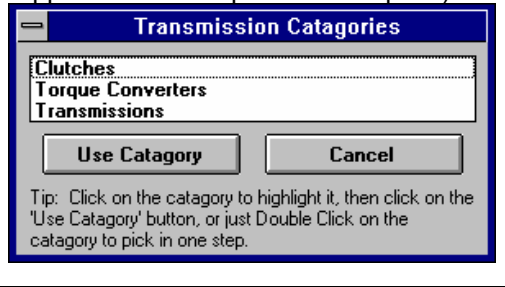

Eventually you will obtain a list of examples, like shown in Figure 2.37. Here you can select your choice by either clicking on it, then clicking on the Pick button, or double clicking on it. (By single clicking on an example you have saved (not one

Figure 2.37 List of Body Details Examples

Examples										
Vehicles	Layout	Rr%Wt	CGHt	WhlBs	RTWdth	FrntStfns	FArea	Drag		
69-70 Mustang Big Block	Rear W	42	24	108	59	No Frnt S	22	.48		↑
69-70 Mustang Small Block	Rear W	44	24	108	59	No Frnt S	22	.48		
79-86 Mustang 5.0L	Rear W	40	22	101	57	Modern Pr	21	.42		
87-93 Mustang 5.0L	Rear W	40	22	101	57	Modern Pr	21	.39		
80s Cutlass-BuickGN-etc	Rear W	45	22	108	59.3	Modern Pr	24	.45		
82-92 Camaro/Firebird	Rear W	40	22	101	60	Modern Pr	21	.38		
Typ Rear Engine Sports Car	Rear W	61	19	96.5	63	Modern Pr	20	.37		
71-82 Camaro/Firebird	Rear W	44	22	108	60	Modern Pr	22	.47		
67-70 SE Camaro/Firebird	Rear W	44	22	108	60	No Frnt S	20	.48		
67-70 BE Camaro/Firebird	Rear W	42	22	108	60	No Frnt S	20	.48		
65-68 Mustang Small Block	Rear W	47	22	108	56	No Frnt S	20	.5		
65-68 Mustang Big Block	Rear W	44	22	108	56	No Frnt S	20	.5		
94-98 Mustang V-8	Rear W	44	22	101	59	Modern Pr	20	.37		
67-69 Barracuda Big Block	Rear W	42	22	108	61	No Frnt S	21	.5		
67-69 Barracuda Small Blck	Rear W	44	22	108	61	No Frnt S	21	.5		↓

Tip: Click to highlight example, double click to choose example.

Pick Delete Cancel

provided by Performance Trends) you can click on Delete to delete it.)

Next you will be shown a comparison of the example you chose and the current specs, as shown in Figure 2.38. Click on Back to return to Figure 2.37. Click on Load In These Example Specs to use these specs. You will then be given a notice about how these specs can not describe all details of the example just chosen, and you should still use your own judgment about the results. See Figure 2.39.

You have the option of changing the Example specs. For example, lets say you have lowered your

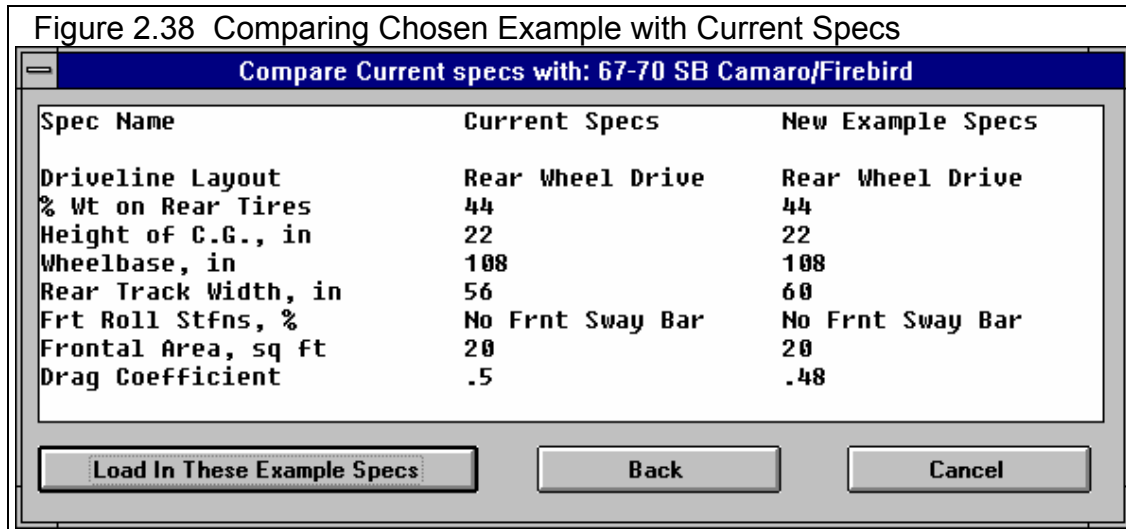

Mustang. You calculate the new Frontal Area is only 18 square feet. You can click on Frontal Area and

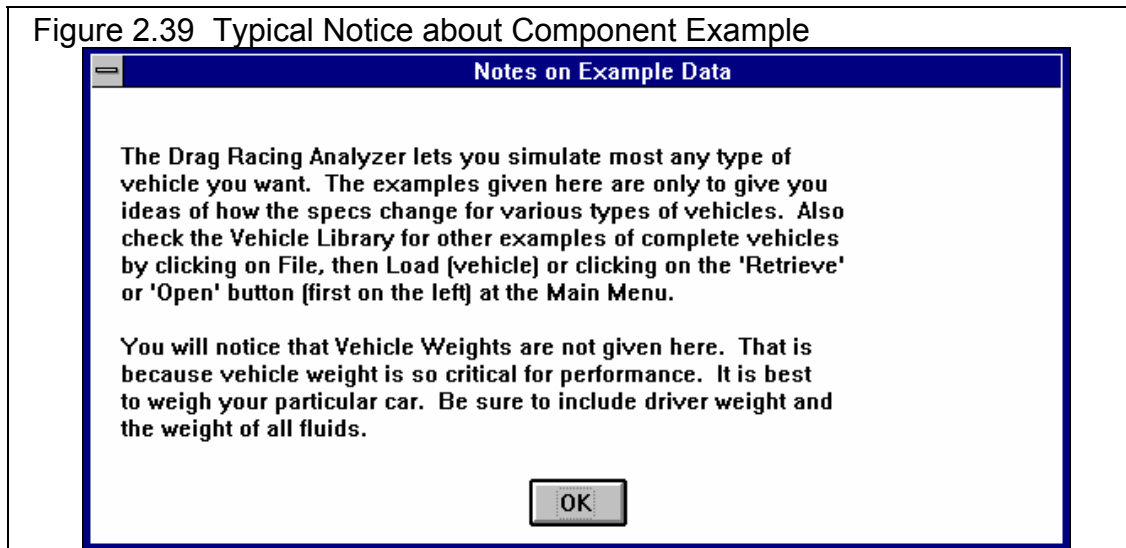

type in 18 and press <Enter>. The program will warn you that by changing this spec, the name of the example will no longer be for a Mustang, but will be changed to the general "Use Specs Below".

You also have the example of saving your own sets of specs to the list of Component Examples. If the current specs are not an example, click on the Save Example button to be presented with the screen of Figure 2.40. Select Save and these specs will be saved to the example list with the name you entered.

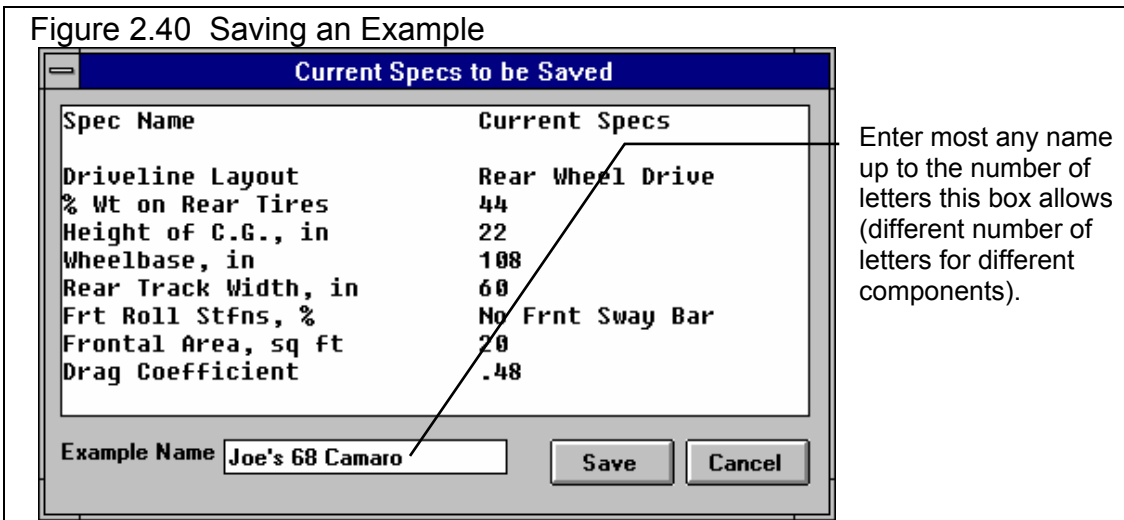

Notes:

- Not all specs have Examples available and some Example categories have very few examples from which to choose. These features will expand with later updates.
- The specs in these Examples are approximate. Different pieces of hardware and later designs may have different specs, producing very different results. You will be more accurate if you use your own figures from your own tests, or the latest information from the manufacturer.
- No checks are made to see if your combination of Examples is physically possible. You can choose to put Ford 'Toploader' transmission gear ratios behind a 5 HP Briggs & Stratton engine in a Prod 82 Corvette body type. This may be an interesting "what if", but you must realize this hardware will NOT bolt together.

Chapter 3 Output

The Drag Racing Analyzer provides several ways to view and output the test results, including:

- Tabular, calculated Test Results displayed on the screen. Check Section 2.7 for definitions of Test Results.
- Analysis Report giving tips, warning of safety issues, etc.
- High resolution graphs
- Printer output or reports or graphs
- Vehicle Library for recording sets of vehicle specs for later use

Figure 3.1 Output Options from Test Results Screen

Menu Bar showing names of options

Vehicle File Name

Click on and slide side bar button to display all Test Results.

Click on and slide side bar button to display entire History Log.

Performance Summary

Notes Summary and Notes button giving performance tips

Command Option Buttons

Gear	Time	MPH	Accel Gs	Feet	C RPM	EngRPM	Tq Mult	C Slip	T Slip	% Thrt
1	-.27	.0	.56	-1	0	3000	1.00	100	5	48
RO	.00	3.3	.56	0	479	4091	1.00	88	5	48
1	2.30	31.5	.56	60	4617	5047	1.00	9	5	49
1	2.50	33.9	.57	70	4981	5000	1.00	0	5	50
2	2.90	33.7	.57	90	2854	5175	1.00	45	5	87
2	5.94	60.0	.30	307	4911	4911	1.00	0	2	100
2	6.13	61.2	.29	324	5000	5000	1.00	0	1	100
2-3	6.20	61.2	-.04	330	4991	5030	1.00	1	1	50
3	6.52	60.9	.41	359	3316	5170	1.00	36	3	100
3	9.45	77.3	.23	660	4177	4177	1.00	0	1	100
3	12.22	89.3	.17	1000	4812	4812	1.00	0	0	100
3	13.25	92.9	.15	1138	5000	5000	1.00	0	0	100
4	13.65	92.3	.27	1193	3847	5175	1.00	26	1	100

Test Title	Feet	Dnsy Alt	Dry Dnsy Alt	60 ft	Imprvmt	ET	Imprvmt	MPH	Imprvmt
gt5.0l: Tue Apr 14 98 8:03 pm	1320	294	618	2.30	3.32	4.57	16.12	94.93	46.50
gt5.0l: Tue Apr 14 98 8:07 am	1320	294	618	5.62	.00	30.69	.00	48.43	.00
gt5.0l: Tue Apr 14 98 7:18 am	1320	294	618	5.62	-3.32	30.69	-16.12	48.43	-46.50
gt5.0l: Mon Apr 13 98 9:57 pm	1320	294	618	2.30	.25	4.57	-.04	94.93	-4.43
69-mach1: Fri Apr 10 98 10:48 am	1320	1789	2138	2.55	.02	4.53	-.14	99.36	-1.70
69-mach1: Fri Apr 10 98 9:56 am	1320	294	618	2.57	.00	4.39	.00	101.06	.00
69-mach1: Thu Apr 9 98 6:45 pm	1320	294	618	2.57	-.20	4.39	-.47	101.06	-.51

Click on Test Title (1st column) to change it or to retrieve specs which produced those results. Click in other columns for definitions.

Figure 3.2 Additional Output Options

Click here or here to graph these results

Click here or here to print these results

Click here to create Analysis Report (giving performance tips) as described in Section 3.2

Click here for History Log options

Click here for help on Test Results

Drag Racing Analyzer v3.0 Performance Trends [GT5.0L]

Back Graph Print Analyze History Help(F1)

Notes Summary: High Clutch Slip, Tire Traction Low. Click on Notes for more Details.

Current: ET 14.57 MPH 94.93
Last: 30.69 48.43
Improvement: 16.12 46.50

Gear	Time	MPH	Accel Gs	Feet	C RPM	EngRPM	Tq Mult	C Slip	T Slip	% Thrt
1	-0.27	.0	.56	-1	0	3000	1.00	100	5	48
RO	.00	3.3	.56	0	479	4091	1.00	88	5	48
1	2.30	31.5	.56	60	4617	5047	1.00	9	5	49
1	2.50	33.9	.57	70	4981	5000	1.00	0	5	50
2	2.90	33.7	.57	90	2854	5175	1.00	45	5	87
2	5.94	60.0	.30	307	4911	4911	1.00	0	2	100
2	6.13	61.2	.29	324	5000	5000	1.00	0	1	100
2-3	6.20	61.2	-.04	330	4991	5030	1.00	1	1	50
3	6.52	60.9	.41	359	3316	5170	1.00	36	3	100
3	9.45	77.3	.23	660	4177	4177	1.00	0	1	100
3	12.22	89.3	.17	1000	4812	4812	1.00	0	0	100
3	13.25	92.9	.15	1138	5000	5000	1.00	0	0	100
4	13.65	92.3	.27	1193	3847	5175	1.00	26	1	100

Test Title	Feet	Dnsy Alt	Dry Dnsy Alt	60 ft	Imprvmt	ET	Imprvmt	MPH	Imprvmt
gt5.0l: Tue Apr 14 98 8:03 pm	1320	294	618	2.30	3.32	14.57	16.12	94.93	46.50
gt5.0l: Tue Apr 14 98 8:07 am	1320	294	618	5.62	.00	30.69	.00	48.43	.00
gt5.0l: Tue Apr 14 98 7:18 am	1320	294	618	5.62	-3.32	30.69	-16.12	48.43	-46.50
gt5.0l: Mon Apr 13 98 9:57 pm	1320	294	618	2.30	.25	14.57	-.04	94.93	-4.43
69-mach1: Fri Apr 10 98 10:48 am	1320	1789	2138	2.55	.02	14.53	-.14	93.36	-1.70
69-mach1: Fri Apr 10 98 9:56 am	1320	294	618	2.57	.00	14.39	.00	101.06	.00
69-mach1: Thu Apr 9 98 6:45 pm	1320	294	618	2.57	-.20	14.39	-.47	101.06	-.51

Click on Test Title (1st column) to change it or to retrieve specs which produced those results. Click in other columns for definitions.

Click here to return to the Main Menu

Click here to view and/or edit the Vehicle Comments

3.1 Analysis Reports

When calculated test results are displayed on the screen, you can obtain an Analysis Report by clicking on Analyze in the menu bar. The Analysis report consists of 1-3 pages of suggestions for improving performance, *safety warnings*, etc. concerning the performance results calculated. See Figure 3.3 and 3.4 for examples.

Figure 3.3 First Portion of Analysis Report

Drag Racing Analyzer v3.0 Performance Trends [GT5.0L]

Back Graph Print Analyze History Help[F1]

Notes Summary: High Clutch Slip, Tire Traction Low. Click on Notes for more Details

Current: ET 14.57 MPH 94.93
Last: 30.69 48.43
Improvement: 15.12 45.50

Analysis Report

Analysis Report

Wt/HP Ratio = 15.24 (corrected for weather at track)

Comparison of this vehicle's performance to a typical race vehicle:

	This Veh	Typ Veh	Advantage *
60 foot (sec)	2.30	1.79	-.51 sec
660 foot (1/8 mile)	9.45	8.53	-.92 sec
1320 foot (1/4 mile)	14.57	13.34	-1.23 sec
1320 foot MPH	94.93	97.57	-2.64 MPH

* Advantage of This Vehicle over the Typical Vehicle

Your vehicle's 1/4 mile MPH is 94.9 MPH
where a Typical vehicle would run 97.6 MPH.

Print Cancel

Test Title	Date	Time	Dist	Wt	HP	ET	MPH	Wt/HP	MPH/Sec
gt5.0l: Mon Apr 13 98 9:57 pm	1320	294	618	2.30	.25	14.57	94.93	-0.43	-4.43
69-mach1: Fri Apr 10 98 10:48 am	1320	1789	2138	2.55	.02	14.53	99.36	-1.70	

Click on Test Title (1st column) to change it or to retrieve specs which produced those results. Click in other columns for definitions.

IMPORTANT: The Drag Racing Analyzer can NOT anticipate all UNSAFE and poor performing situations. Do NOT rely only on the Analysis report to point out problems and SAFETY HAZARDS. You must use your own judgment, expert advice from experienced engine builders and the manufacturer of the components.

Figure 3.4 Another Portion of Analysis Report

Drag Racing Analyzer v3.0 Performance Trends [GT5.0L]

Back Graph Print Analyze History Help(F1)

Notes Summary: High Clutch Slip, Tire Traction Low. Click on Notes for more Details.

Current: ET 14.57 MPH 94.93
Last: 30.69 48.43
Improvement: 16.12 46.50

Analysis Report

Power is being limited by the program for 25 % of this run to prevent tire spin during the launch. This is somewhat high, and is limiting the vehicle from producing low 60 foot times and ETs.

To reduce the amount of time power is being limited, increase the Traction Factor or specify a higher traction Tire Type in the Wheel/Tire Specs menu. Click on the Examples button to be presented with a list of examples of Traction Factor for various types of tires.

If you are limited to a low value of Traction Factor or are running a Tire Type which is not 'Drag Slicks', try:

- Increase % Wt on Rear Tires in the Vehicle Specs menu
- Increase Height of CG in the Vehicle Specs menu
- Reduce Frt Susp Roll Stiff in the Vehicle Specs menu
- Increase Diff Lock Eff in the Vehicle Specs menu

Print Cancel

Test Title	Date	Time	ET	MPH	60ft	100ft	150ft	200ft	250ft	300ft
gt5.0l: Mon Apr 13 98 9:57 pm	1320	294	618	2.30	.25	14.57	-.04	94.93	-4.43	
69-mach1: Fri Apr 10 98 10:48 am	1320	1789	2138	2.55	.02	14.53	-.14	99.36	-1.70	

Click on Test Title (1st column) to change it or to retrieve specs which produced those results. Click in other columns for definitions.

3.2 Graphs

Graphs are obtained by clicking on the Graph button or the Graph menu command in the Test Results screen shown in Figure 3.2. Graphs can be of 7 types of data and may include a baseline graph of some previous run, depending on the settings of certain Options.

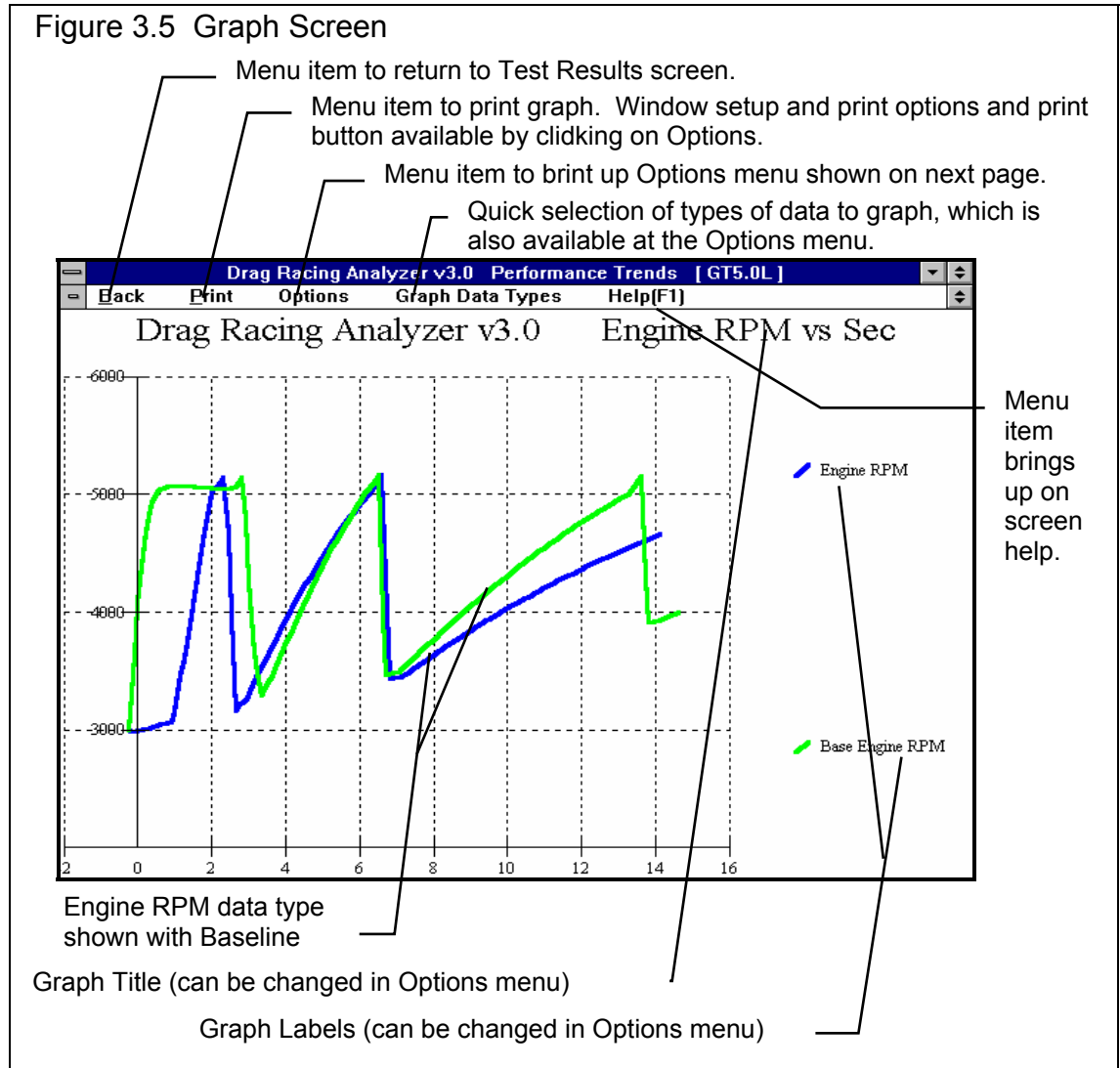

Appendix 5, page 169, New Features in v3.4 B discusses new Graphing features.

A typical graph is shown on the previous page with some explanation of features. The next pages show the Graph Options window and discusses these options.

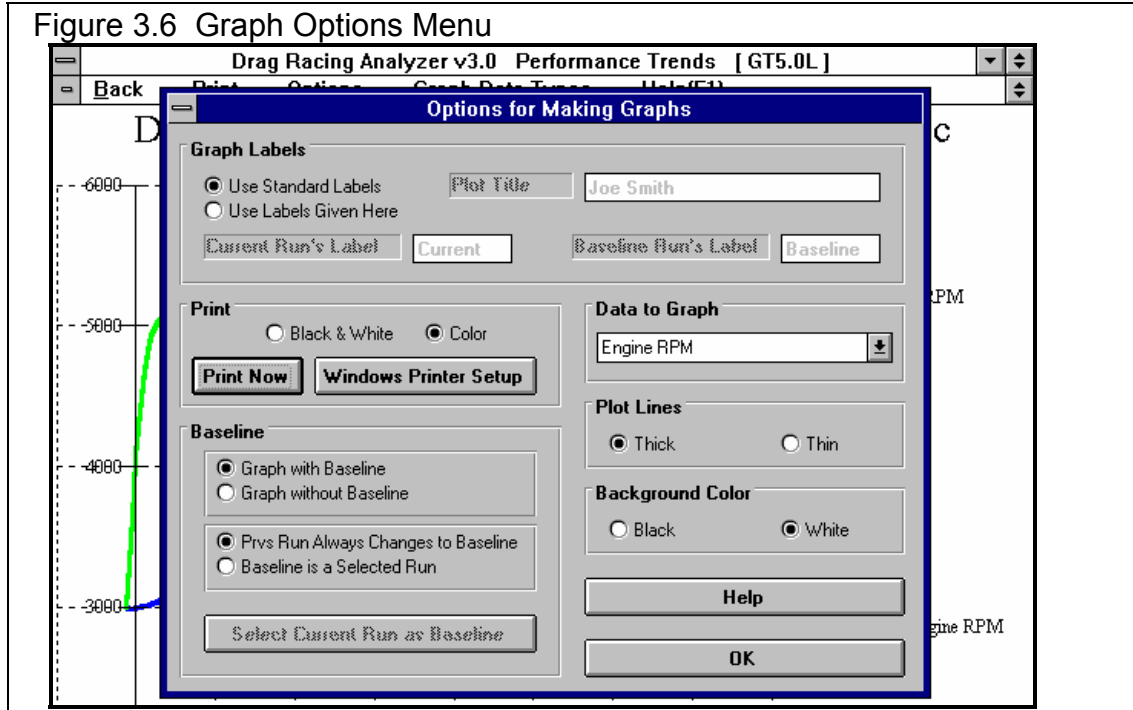

Figure 3.6 Graph Options Menu

Graph Labels

- Use Standard Labels
- Use Labels Given Here

Select "Use Standard Labels" for the program to put its standard labels on the graph. Select "Use Labels Given Here" for the program to use the labels you can enter or change in this section of the Graph Options window.

- Current Run's Label
- Baseline Run's Label
- Plot Title

Click on these 3 text boxes to enter or change the labels or the graph title. You must select "Use Labels Given Here" before you can enter or change any of these specs.

Print

Black and White Color

Select either “Black and White” or “Color” to tell the program how to print the graph. Unless you have a color printer, you should choose “Black and White”. The program always graphs in color on the computer screen.

Print Now

Click on the “Print Now” button to print the current graph on the printer, the same as selecting the “Print” menu command.

Data to Graph

Click on this combo box for the following list of Data Types to graph:

- Engine RPM
- MPH
- Feet
- Accel Gs
- Engine HP
- Clutch % (see Figures 2.14 - 2.17 on pages 43-48)
- Throttle % (see Figures 2.14 - 2.17 on pages 43-48)
- Clutch or Converter and Engine RPM (useful to check for clutch or converter slip)

See Section 2.7 for more information about these data types.

Plot Lines

Thick Thin

This section lets you pick the thickness of the graph lines. Thick lines may show up better on the screen, but thin lines let you spot minor differences more easily. This spec also affects how the graphs are printed.

Background Color

This section lets you pick the background color of the graph, either black or white. Even if you select black, the background color when you print the graph will be white in most all cases.

Baseline

Graph with Baseline

Graph without Baseline

Click on “Graph without Baseline” for only the current run’s data to be graphed. Click on “Graph with Baseline” to have ‘Baseline’ data plotted from a previous run for comparison. You must click on “Graph with Baseline” before other options in this section are available.

Prvs Run Always Changes to Baseline

Baseline is a Selected Run

Click on “Prvs Run Always Changes to Baseline” and the previous data will be the baseline run plotted. This is handy if you want to check the effect of every modification. Simply make a change in a vehicle spec, calculate performance and then make a plot and the difference in the last 2 runs will be graphed.

Click on “Baseline is a Selected Run” and one run remains the Baseline while you make several calculations. When you first click on this option or the “Select Current Run as Baseline” button, the current data is saved as the Baseline run. This is handy if you have a particular combination you are trying to improve upon while making several changes.

Select Current Run as Baseline

Click on this button to change the Baseline run to the current data. This option is only available if you have selected the options “Graph with Baseline” and “Baseline is a Selected Run”.

Appendix 5, page 169, New Features in v3.4 B discusses new Graphing features.

3.3 Vehicle Library

The Drag Racing Analyzer allows you to save a set of vehicle specifications to the Vehicle Library under a name of your choosing. You can then open these vehicles out of the Vehicle Library in the future for comparison or modification. The Open window is shown on the next page with explanations.

Figure 3.7 Vehicle Library Options

Click on Open button (or 'File (vehicle)', then 'Load') to display Vehicle Library shown here. (Save option also available after clicking on 'File (vehicle)'.)

Click on Save button to save current Vehicle specs to Library

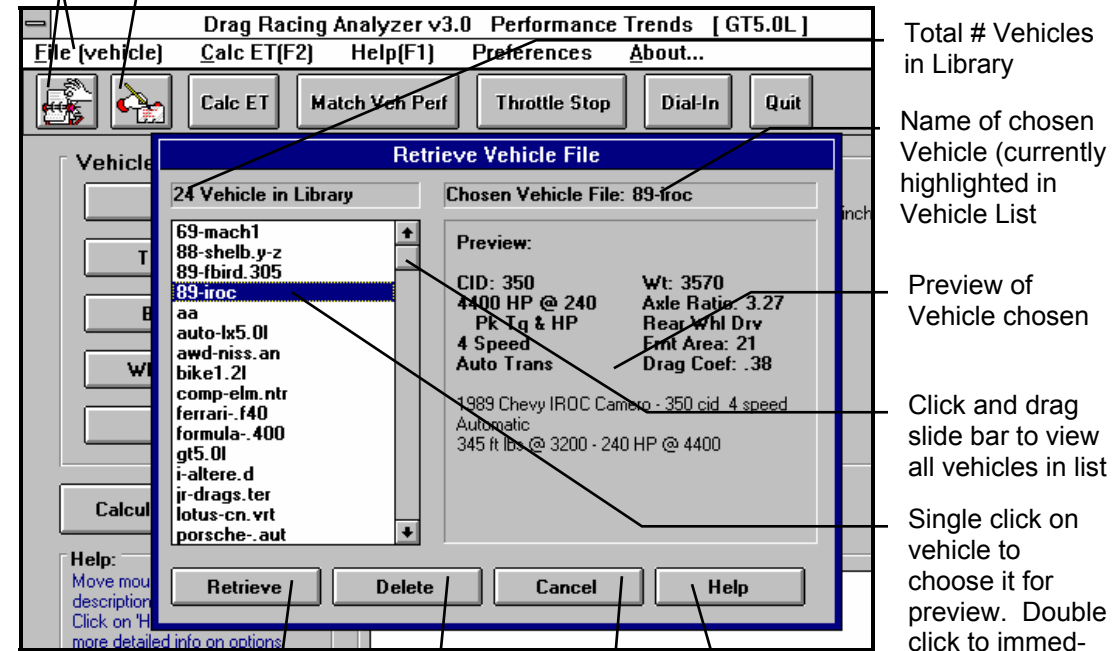

Total # Vehicles in Library

Name of chosen Vehicle (currently highlighted in Vehicle List

Preview of Vehicle chosen

Click and drag slide bar to view all vehicles in list

Single click on vehicle to choose it for preview. Double click to immediately open it.

Click here to open the chosen

Click here to delete chosen Vehicle.

Click here to close the Vehicle Library with No changes (without opening a vehicle)

Click here to bring up on screen help.

Open a Vehicle File

To open a vehicle file saved in the Library, either:

- Click on the Open button
- Click on the “File (vehicle)” menu item and then on the “Open Vehicle” options from the list.

You will obtain the window shown on the previous page. Single click on one of the vehicles in the list, or click and drag the slide button on the right side of the list to display more vehicles. Once you single click on a vehicle, it is now the Chosen Vehicle File and a preview of the vehicle is given in the Preview section. If the file you chose was not a valid Drag Racing Analyzer file, the program will tell you and you can not choose it.

Once a vehicle has been chosen, you can delete it by clicking on the Delete button, or Open it by clicking on the Open button in this window. You can also click on a different vehicle to Preview it or close this window and return to the Main Menu without choosing a new vehicle file.

If you are sure of the vehicle you want to open, you can simply double click on it from the Vehicle List. This opens the vehicle without a preview and closes this menu.

Save a Vehicle File

Before we discuss saving an engine file, it is important for you to understand how the program opens and uses vehicle files. When you open a vehicle from the Vehicle Library, you are only using a *copy* of the vehicle. The original vehicle file is kept in the library.

As you make changes to the vehicle, they are only made to this copy. The original file is not changed. If you want to delete your changes, you can simply open a fresh, unchanged copy of the original vehicle file from the Library. If you want to keep your changes, *you must save them*. This can be done by clicking on the Save button. You are also asked if you want to save your changes whenever you open a new vehicle, and the program has detected you have made changes to the current file.

To save a Vehicle File, you will be presented with the Save Window as shown on the next page. The program suggests a new vehicle name which is the same as the current vehicle name shown at the top of the Main Menu. If you want to save your changes to the same name, simply click on OK. This will update the current vehicle file with your latest changes.

If you want to save the current set of vehicle specs with your changes to a new name (and leave the current vehicle file in the Library unchanged), then click on the suggested file name and modify it as you want. For example, in the window shown on the next page, you may want to add -2 to the current name MUSTANG to create MUSTANG-2 to indicate this is the 2nd revision of MUSTANG. This is the safest way to make changes, because you can always return to an earlier version and see what you had done.

Figure 3.8 Saving Vehicle File Options

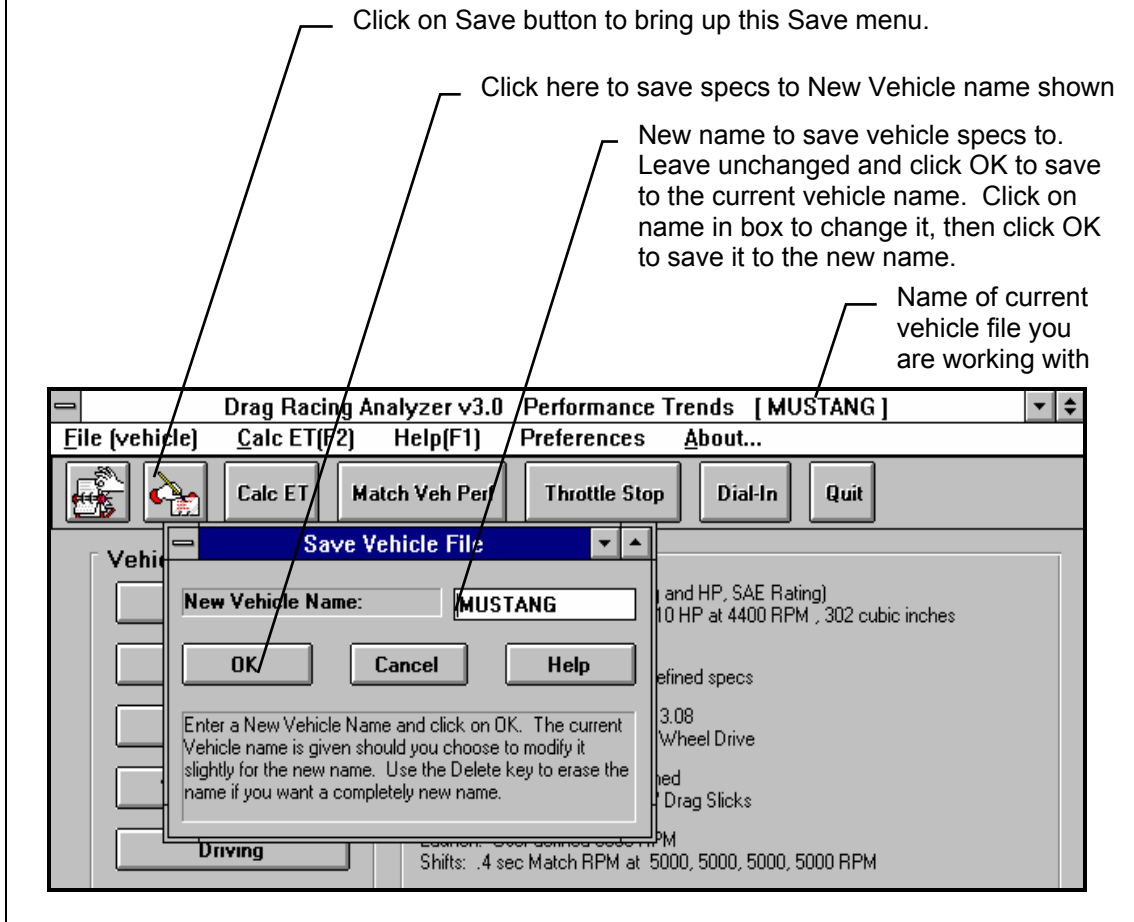

Certain vehicle names are not acceptable, including:

- Names over 50 characters long.
- Names which include certain special characters, like the slash “/”. The program will warn you if a character is not acceptable.

Vehicle files are saved in the VEHDAT subdirectory in the DRA30 (subdirectory under PERFTRNS.PTI directory). Unlike earlier DOS Drag Racing Analyzer programs, you *can* copy Windows Drag Racing Analyzer files from programs on other computers to this directory and they will be found by the program.

In version 3.4, the path to the VehDat folder is now:

C:\Program Files\Performance Trends\Drag Racing Analyzer v3.4

On Windows 7 and Vista computers it can be:

C:\Program Files (x86)\Performance Trends\Drag Racing Analyzer v3.4

3.4 Printer Output

The Drag Racing Analyzer can print the tabular test results for a permanent hardcopy by clicking on Print in the menu bar or the Printer button. The menu of options shown in Figure 3.9 will appear. Check the options you want to use for the printout by clicking on any or all of the top for boxes. All options and buttons are discussed in this section.

Figure 3.9 Printer Command and Menu of Printer Output Options

The Windows Printer Setup option lets you choose the printer or printer driver being used by Windows and also the page orientation.

Click on Print or the Printer Button for the Printout Options menu shown to the right.

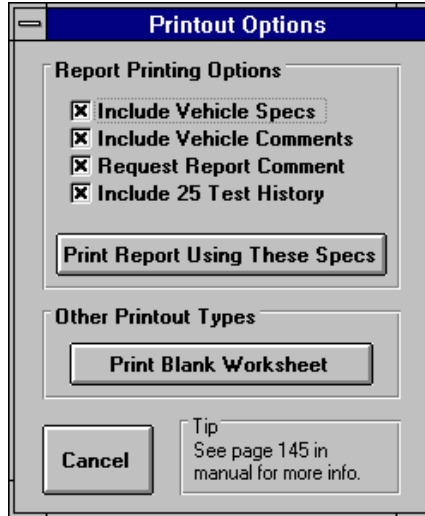
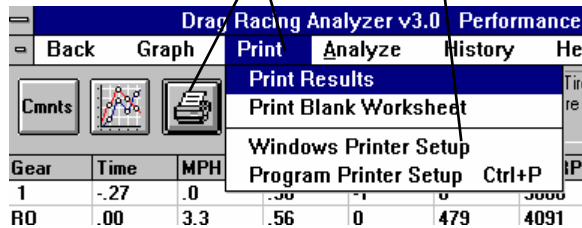

Include Vehicle Specs

Select this options if you want all the current Engine specs, Transmission specs, etc printed with the results. This will add 1 page to the printed report.

Include Vehicle Comments

Select this option if you want all the comments for the complete vehicle printed with the results.

Request Report Comment

Select this option if you want to be asked for a comment for each particular report you send to the printer. These "report comments" are useful to identify important points for future reference, like modifications, weather conditions, etc.

See Appendix 3 and 4 for new Print features added in v3.2, 3.4 and 3.4 B. Version 3.4 also allows you to include a graphics image (photograph) of your car for printing.

3.5 History Log

The Drag Racing Analyzer remembers the results and the vehicle specs which produced those results for up to the last 25 runs you have made. This can be a very hand comparison of one run to another and saves you the trouble of making notes on pieces of paper. It is also handy to be able to go back to some condition which gave very good performance, but you don't remember why or what the specs were.

Figure 3.10 shows the History Log and options. Example 4.1 discusses the History Options in detail.

Figure 3.10 History Log and Options

Click on History for Options

Click on Test Title to change the Title or retrieve the specs which produced these results.

History Log is displayed below the columns of test results.

Click and move slide bar to display all 25 tests in the History Log.

Gear	Time	MPH	Accel Gs	Feet	C Slip	T Slip	% Thrt
1	2.294	34.0	.57	538	1.00	5	47
RO	.000	3.7	.57	0	1.00	5	48
1	2.272	32.2	.58	4727	1.00	7	49
1	2.416	34.0	.58	4994	1.00	5	49
2	2.816	33.8	.58	2861	1.00	45	86
2	5.742	60.0	.31	294	1.00	0	100
2	5.936	61.3	.29	311	1.00	0	1
2-3	6.147	61.1	.34	330	1.00	2	1
3	6.335	60.9	.42	347	1.00	26	3
3	9.374	78.4	.23	660	1.00	0	1
3	12.108	90.4	.17	1000	1.00	0	0
3	12.813	92.8	.15	1095	1.00	0	0
4	13.213	92.2	.28	1149	1.00	26	1

Test Title	Feet	Dnsy Alt	Dry Dnsy Alt	60 ft	Imprvmt	ET	Imprvmt	MPH	Imprvmt
gt5.0l: Wed Apr 22 98 2:47 pm	1320	294	618	2.272	.000	14.441	.000	96.01	.00
gt5.0l: Tue Apr 21 98 3:59 pm	1320	294	618	2.272	.001	14.441	.071	96.01	.67
gt5.0l: Tue Apr 21 98 3:58 pm	1320	294	618	2.273	.024	14.512	.081	95.34	.37
gt5.0l: Tue Apr 21 98 3:58 pm	1320	294	618	2.297	-.887	14.593	-4.644	94.97	-.39.05
sg-grand.-am: Tue Apr 21 98 9:25 am	1320	1472	2051	1.410	-.002	9.949	-.021	134.02	-.37
sg-grand.-am: Tue Apr 21 98 9:25 am	1320	1415	1995	1.408	.006	9.928	.080	134.39	1.22
sg-grand.-am: Tue Apr 21 98 9:25 am	1320	1539	2147	1.414	-.021	10.008	-.327	133.17	-5.14

Click on Test Title (1st column) to change it or to retrieve specs which produced those results. Click in other columns for definitions.

Test Title

Click on Test Title and you are asked if you want to retrieve the specs which produced these results. Answer Yes and the specs are retrieved. Answer No and you can then change the Test Title. This is useful for making notes about this particular run, modifications you made, etc.

Feet

Is the distance of the race. The “Imprvmnts” in the History is only shown if the runs were for the same distance.

Dnsy Alt

Density Altitude in feet above sea level of the current track weather conditions. Many racers like this number for comparisons. It basically means for a standard 29.92" barometer, 60 deg, 0% humidity day what altitude would give the same *barometric pressure* as the current track conditions.

Dry Dnsy Alt

Dry Density Altitude in feet above sea level of the current track weather conditions, sometimes called Corrected Density Altitude (corrected for humidity). It basically means for a standard 29.92" barometer, 60 deg, 0% humidity day what altitude would give the same *oxygen content* as the current track conditions. This is a better measure than Density Altitude for your car's true HP potential.

60 ft

Imprvmnt

ET

Imprvmnt

MPH

Imprvmnt

Are the test results for the particular run. The Imprvmnts are the improvement of a particular run over the previous run. Imprvmnt is left blank if the previous run was not for the same Feet distance as that particular run in the History log.

If the Feet distances are 5280 (1 mile) or 7040 ft (the distance of El Mirage), the 60 foot time is actually the 660 foot (1/8 mile) time . If the Feet distance is are 26400 (the distance of Bonneville), the 60 foot time is actually the 2 mile time .

Chapter 4 Examples

Each of these examples become progressively more complex, assuming you have performed and understand the preceding example. Section 1.5's example is somewhat more basic than Example 4.1, so it may be a better place to start if Example 4.1 looks complicated.

The results shown in these examples may be somewhat different than what you obtain with your particular version of the program. That is due to minor upgrades in the calculations in later versions.

Example 4.1 Finding the Best Axle Ratio

Features Introduced (and suggested background reading):

- Read the Preliminary "Example To Get You Going" (Section 1.5)
- Moving around in the menus and changing specs (Section 2.0, 2.2-2.6)
- Calculate Performance and evaluating results (Section 2.7)
- History Log (Section 3.5)
- Obtaining a printed hardcopy of the results (Section 3.4)

Example 4.1 will be fairly simple to get you started. We will simulate a popular modification, installing a different rear axle ratio. We will see the effect on 60 ft times, ET and MPH.

First, start the Drag Racing Analyzer program following the procedure in Section 1.4 by either:

- Clicking on the Drag Racing Analyzer v3.0 icon in the Perf. Trends program group (Windows 3.1)
- Clicking on Start, Programs, Perf. Trends, then Drag Racing Analyzer v3.0 (Windows 95)
- Clicking on the DRA.EXE (DRA) program under the DRA30 directory (folder) under the PERFTRNS.PTI directory (folder) using File Manager (Windows Explorer). (Terms in parentheses are for Windows 95.)

You will be shown the Drag Racing Analyzer's Main Menu. Notice at the top of the screen that the current Vehicle file is a GT5.0L (85 Mustang).

If it is not GT5.0L or if you think the current GT 5.0L's specs have been changed, you can Open up this Vehicle file by clicking on the Open button as shown in Figure 4.2. Open the Vehicle file GT5.0L shown in Figure 4.2. If you have made any changes to the vehicle which originally appeared at the top of the Main Menu, the program will first ask you if you want to save these changes. Answer No and you will be returned to the Main Menu with the GT5.0L specs loaded into the program.

If you have a faster computer (Pentium), you may want calculations done in a slower, but more precise way. This can be done by clicking on Preferences at the top of the Main Menu (Figure 4.1), then selecting .001 Sec Increments. These increments will be used for all examples.

Click on the different categories of vehicle specs or the Calculate Performance button on the Main Menu. Since we want to see the effect of changing the axle ratio on this vehicle, we first need to get a "baseline" test. A "baseline" is a performance test before the modification. Therefore, if you examine the contents of any component menus, leave all current values as they are.

Figure 4.1 Main Menu

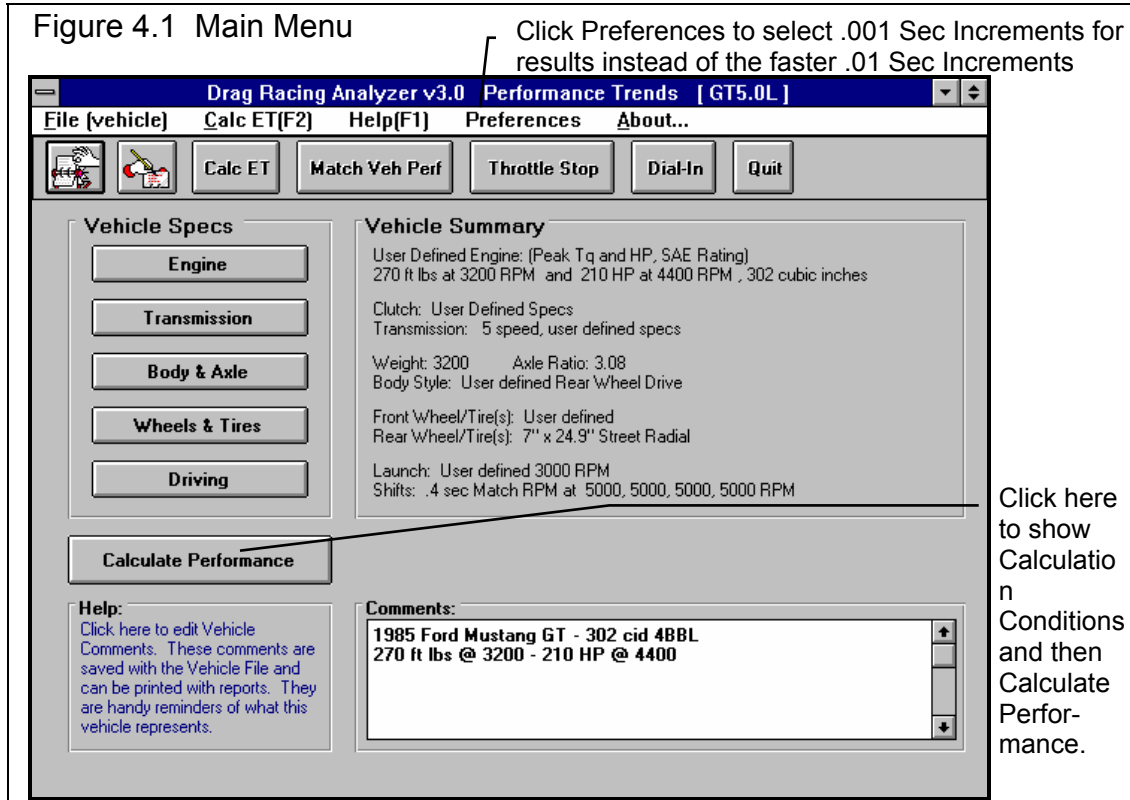

Click on the Calculate Performance button and you will now be shown the Calculation Conditions screen. This screen gives the conditions for calculating performance like track weather and wind, the length of the run and the rollout distance. For now, leave these values as they are.

Proceed with the calculations by clicking on the Calculate Performance button in this menu.

Before calculations are started, basic checks are made of the input specs for unusual combinations, like a shift RPM higher than the engine's maximum RPM, a clutch that is too small for the engine, etc. In this case, the program sees no problems and the calculations proceed.

The program will display the Calculation Progress indicator as calculations progress. When the calculations are finished, the performance results will look like Figure 4.3. You now see a screen with columns of numbers describing the GT5.0L's run through the quarter mile. At the top in the right corner is a summary of the run and any improvement between the current run and the last run. The Last run can be from the last time you ran the program. (The program remembers results from different sessions, between shutdowns and start ups.)

Figure 4.2 Vehicle Library

Drag Racing Analyzer v3.0 Performance Trends [GT5.0L]

File [vehicle] Calc ET(F2) Help(F1) Preferences About...

Retrieve Vehicle File

25 Vehicle in Library

Chosen Vehicle File: gt5.0l

Preview:

CID: 302 Wt: 3200
 4400 HP @ 210 Axle Ratio: 3.08
 Pk Tq & HP Rear Whl Drv
 5 Speed Frnt Area: 21
 Manl Trans Drag Coef: .42

1985 Ford Mustang GT-302 cid 48BL
 270 R lbs @ 3200 - 210 HP @ 4400

Retrieve Delete Cancel Help

Click here to show Vehicle Library

Name of Vehicle the program is currently working with. The current specs may have been changed and be different than the Vehicle in Library of the same name.

Click on the vehicle you want to Open to see a Preview. Double click to Open immediately.

Preview of chosen (highlighted) vehicle.

Figure 4.3 Test Results

Drag Racing Analyzer v3.0 Performance Trends [GT5.0L]

Back Graph Print Analyze History Help(F1)

Notes Summary: High Clutch Slip, Tire Traction Low. Click on Notes for more Details.

Current: ET 14.593 MPH 94.97
 Last: 9.800 136.51
 Improvement: -4.793 -41.54

Gear	Time	MPH	Accel Gs	Feet	C RPM	EngRPM	Tq Mult	C Slip	T Slip	% Thrt
1	-297	.0	.56	-1	0	3000	1.00	100	5	48
RO	.000	3.6	.56	0	533	4197	1.00	87	5	48
1	2.297	31.8	.56	60	4675	5046	1.00	7	5	49
1	2.473	34.0	.57	69	4996	5000	1.00	0	5	50
2	2.873	33.8	.57	88	2862	5175	1.00	45	5	87
2	5.910	60.0	.30	303	4904	4904	1.00	0	2	100
2	6.122	61.3	.28	322	5000	5000	1.00	0	1	100
2-3	6.211	61.3	-.04	330	4990	5041	1.00	1	1	50
3	6.519	61.0	.41	358	3320	5174	1.00	36	3	100
3	9.474	77.4	.22	660	4184	4184	1.00	0	1	100
3	12.240	89.4	.17	1000	4817	4817	1.00	0	0	100
3	13.250	92.9	.15	1135	5000	5000	1.00	0	0	100
4	13.650	92.3	.27	1190	3847	5175	1.00	26	1	100
4	14.593	95.7	.15	1320	3992	3992	1.00	0	0	100

Click here or here to Graph.

Performance Summary showing ET and MPH.

Notes pointing out important things about this run. Click on Notes button or Analyze for more info.

Finish ET and MPH from data columns.

Note the ET of 14.597 seconds with a MPH of 94.97 at the top of the report with the stock 3.08 axle. However, in the columns of numbers you see Feet = 1320, Time = 14.597 sec, but MPH = 95.7, not 94.97. This is because a drag strip has timing lights spaced 66 feet apart at the end of the quarter mile. These lights are used to determine the vehicle's speed at the end of the run. Even though the GT5.0L was doing 95.7 MPH at 1320 FEET, it only averaged 94.97 MPH over the last 66 ft of the 1320 FEET. See Section 2.7.2, Calculate Performance Output.

Other important things to look for in the Test Results screen include:

Notice that the Notes Summary is pointing out a couple of things: Clutch Slip High and Low Tire Traction. If you click on the Notes button, you obtain the screen shown in Figure 4.4. These notes can be useful for understanding your performance, however, for now you are going to stick with the street tires, which are probably limiting performance.

Figure 4.4 Notes Screen Produced by Clicking on the Notes Button

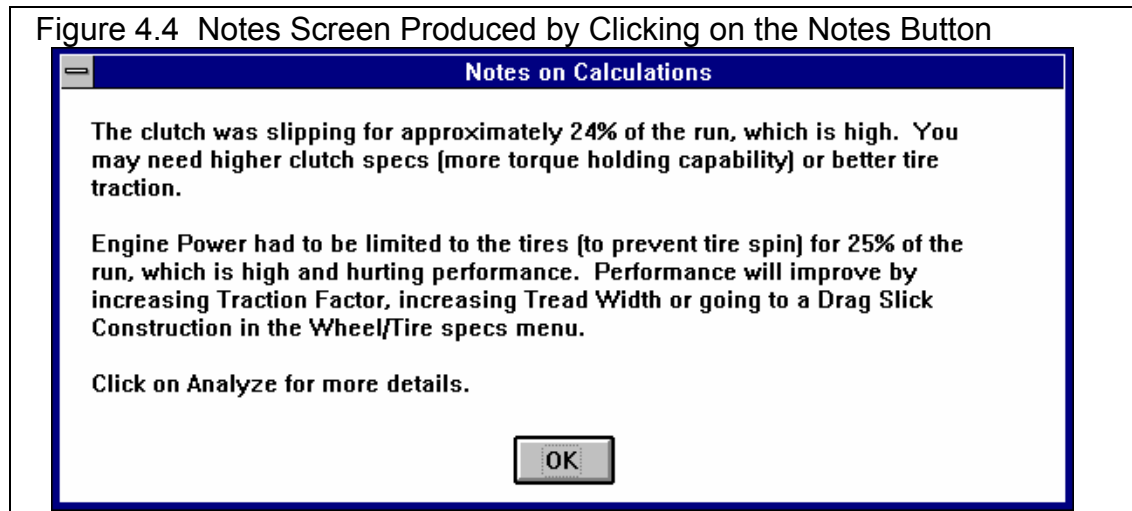

To obtain a graph of these results, click on the Graph button or Graph menu item. The program will present a graph similar to that shown in Figure 4.5 of Engine RPM. If you do not see a graph of Engine RPM, click on Data Types at the top of the graph and select Engine RPM.

Since the Notes pointed out high clutch slip, you might want to try the Converter or Clutch and Engine RPM Graph Data Type. Here you can see where clutch RPM is less than Engine RPM (clutch slipping) and where they match (clutch not slipping). See Figure 4.6.

Much of the reason there is so much clutch slip in first gear is the Launch Type in the Driving Specs menu is set to Computer Driven Launch. The computer is going full throttle on the

Figure 4.5 Engine RPM Graph

Click here for other options
 Click here to change data to be graphed

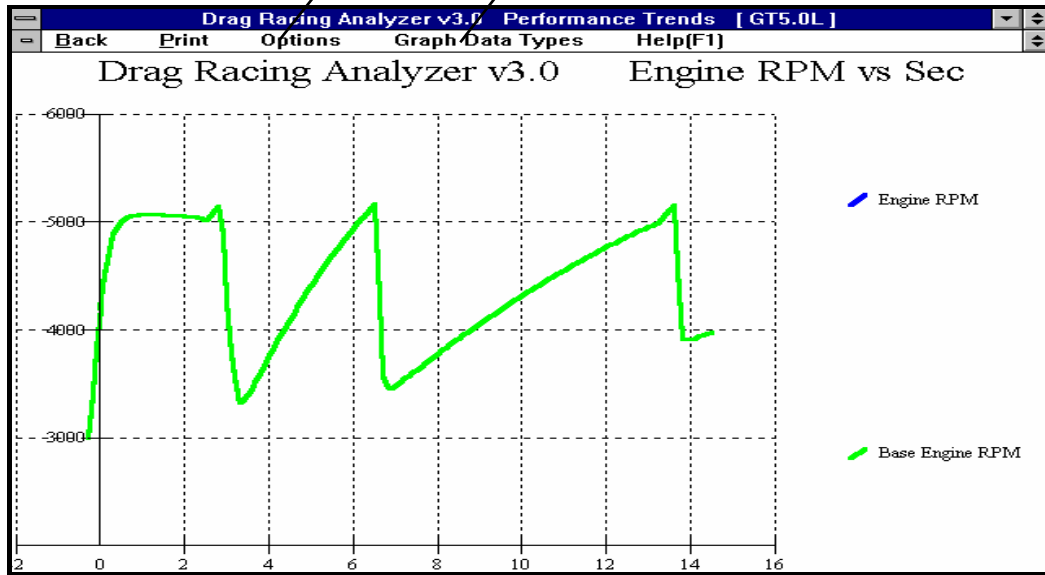
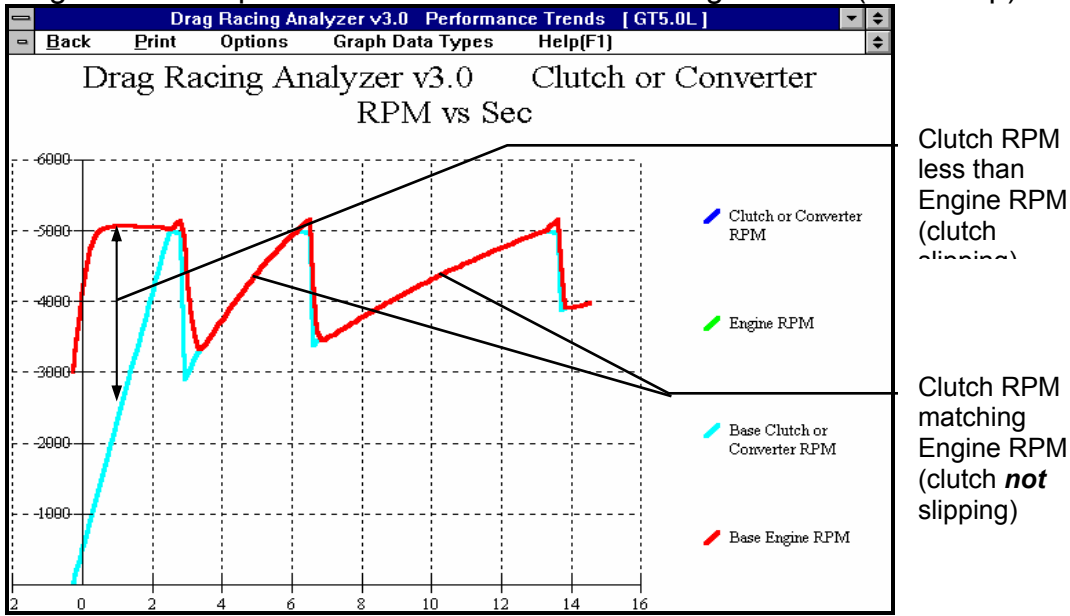

Figure 4.6 Graph of Converter or Clutch and Engine RPM (clutch slip)



engine and “feathering” the clutch to prevent these street tires from breaking loose. This provides for nearly the best launch with these tires, but produces a lot of clutch slip (and clutch wear in the real car).

Changing the Rear Axle Ratio

Now for the good part; lets change the gear ratio and see what happens. Get back to the Main Menu by clicking on Back in the menu bar (or pressing <ESC>) at the graph screen (Figure 4.5), then clicking on Back (or pressing <ESC>) again at the tabular Test Results screen (Figure 4.3).

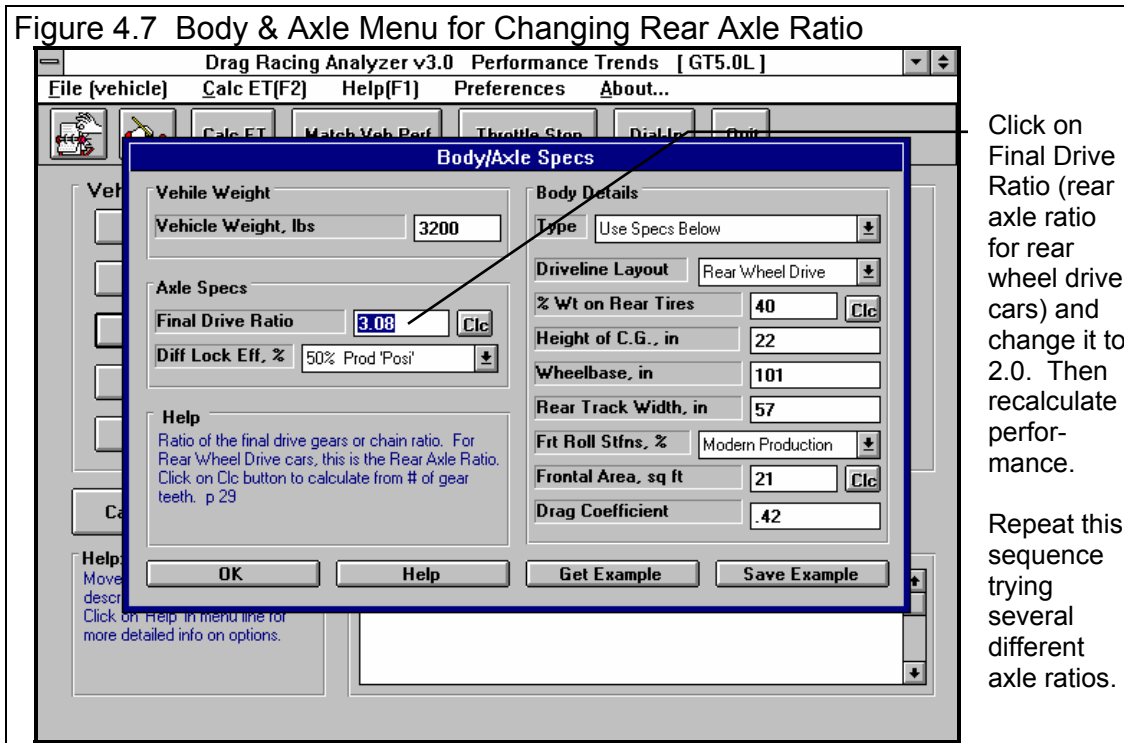

Click on Body & Axle to bring up the menu shown in Figure 4.7. Because you can make many modifications on the computer easily, it is not necessary to install only 1 different axle ratio. In fact, you learn more by installing several ratios with only small changes so you can clearly see trends.

Lets arbitrarily choose axle ratios starting at a point we believe will definitely hurt performance, and increment through what we believe will be the best ratio. For example, we could start at 2.0 and increment in .50 ratio increments to 5.5. With wrenches, money, parts and a drag strip, this could take

several days. On the computer we will be done in a few minutes, with clean fingernails and money left in our wallet!

Click on Final Drive Ratio under Axle Specs and type 2 over the current value of 3.08. (If 2 had not been within acceptable limits, the program will display the limits.) Then click on OK to return to the Main Menu. There you can click on Calculate Performance, then the Calculate Performance button at this menu (as you did before) or just click on the Calc ET button at the top of the Main Menu. The Calc ET button is a shortcut.

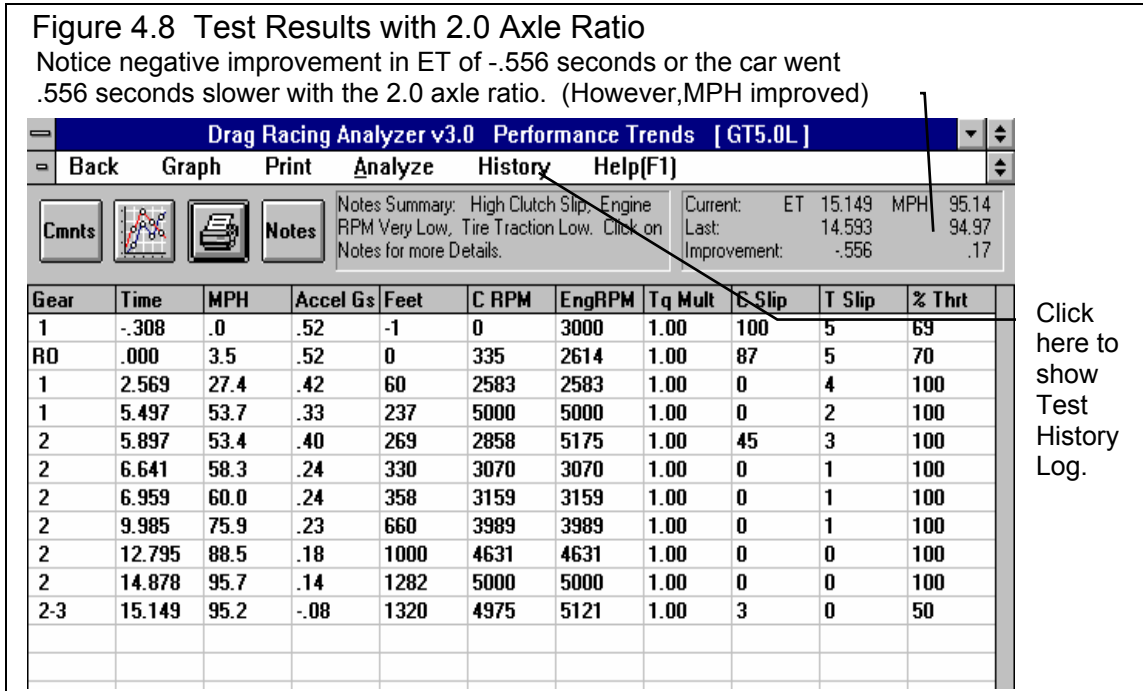

Figure 4.8 shows an ET of 15.149 at 95.14 MPH, with an "improvement" of -.556 seconds (actually a .556 second slower ET). However, MPH actually did improved .17 MPH with the 2.0 axle. This shows a big increase in ET (slower), as we expected. The negative (-) improvements mean that performance was hurt by the last modification.

An alternate way to see this comparison and improvement is to display the Test History Log. Click on History as shown in Figure 4.8 and select Always Show History. You will get the screen of Figure 4.9 with a history and comparison of the last 25 runs. (Although only 7 runs show, you can click and slide the slide bar to see all 25.)

The History Log is a convenient way to keep track of your results to watch trends. We will use it here to find the best axle ratio.

Figure 4.9 Test Results with Test History Log

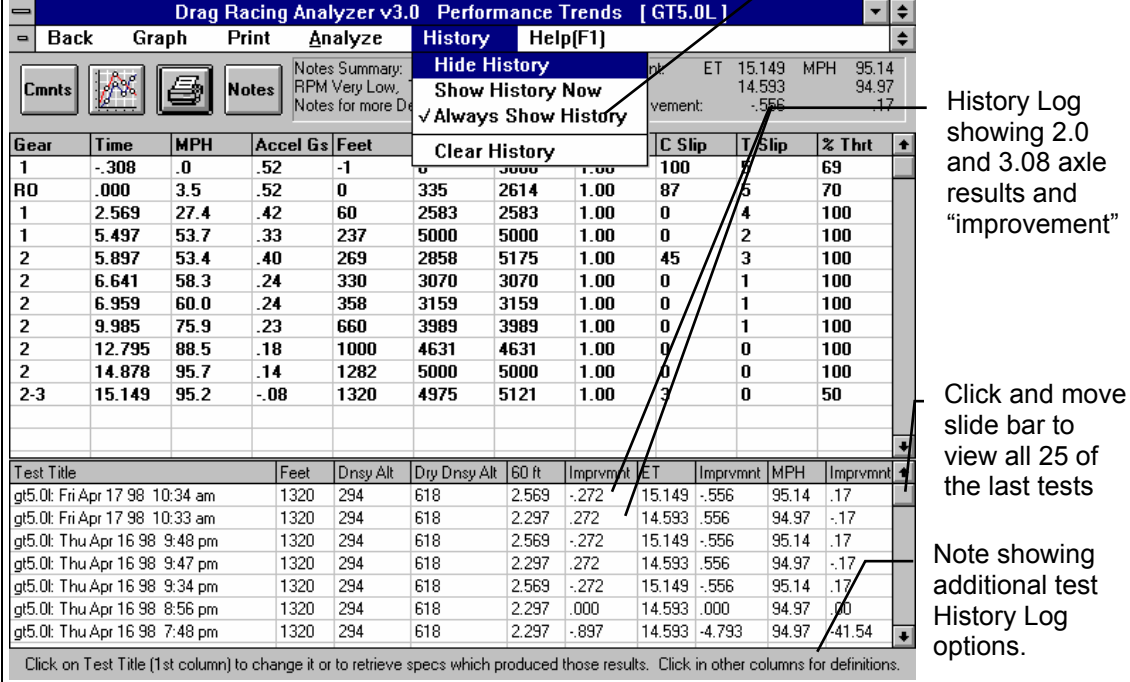
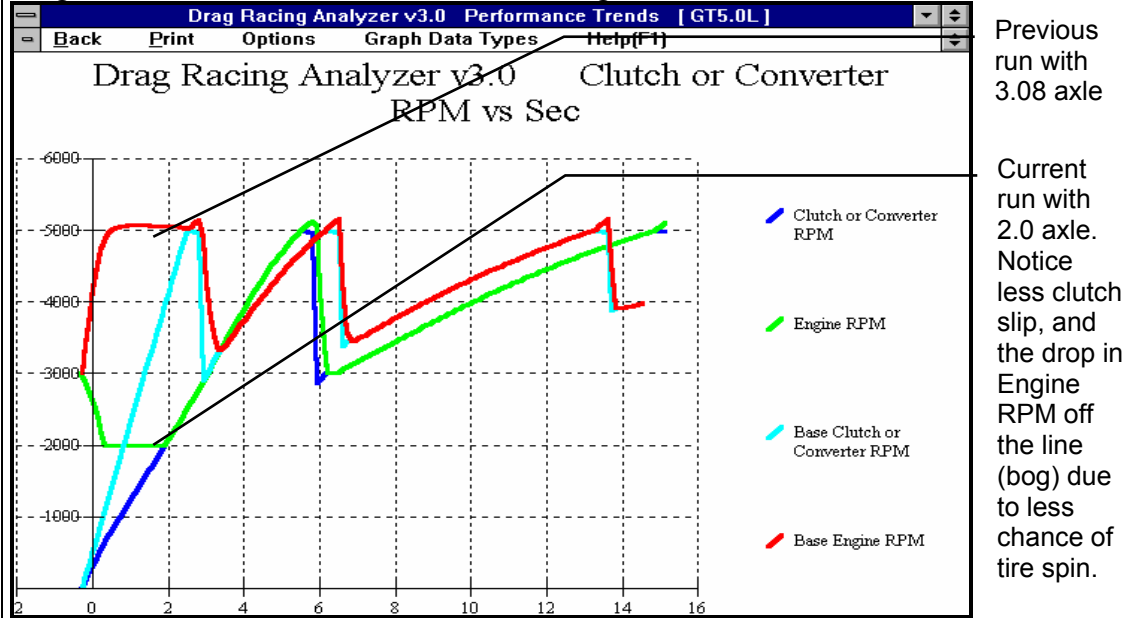

Figure 4.10 Clutch or Converter and Engine RPM



Graph these results with the Baseline 3.08 axle results for the graph in Figure 4.10. Figure 4.10 points out a couple of things:

- Engine RPM drops to 2000 RPM during the launch, possibly “bogging” the engine. That’s because with less torque multiplication in the rear axle, the computer releases the clutch much faster because traction is not a problem. This pulls down engine RPM during the launch.
- The clutch locks up (stops slipping) much faster, again because of less traction problems, the clutch is released faster.
- The run is made in only 2 gears, and finishes the run during the 2-3 shift.

Click on Back to return to the Test Results screen, then click on History and Clear History. You will see all the History rows blanked out except the current 2.0 axle ratio results. Another useful feature of the History Log is the ability to change the Test Title in the first column to anything you want. Click on the Test Title for the 2.0 axle ratio run, then answer No to the question “Retrieve the specs which produced these results?”. You will be shown a test input box like that of Figure 4.11. (You will find the ability to Retrieve specs which produces certain results in the History Log to also be a very useful feature.)

Figure 4.11 Editing Test Title to Track Modifications

Click on Test Title, answer No to the question to edit (change) it.

Drag Racing Analyzer v3.0 Performance Trends [GT5.0L]

Back Graph Print Analyze History Help(F1)

Notes Summary: High Clutch Slip, Tire Traction Very Low. Click on Notes for more Details.

Current: ET 14.690 MPH 94.25
Last: 14.628 95.89
Improvement: -.062 -1.63

Gear	Time	MPH	Ac	C Slip	T Slip	% Thrt
1	1.292	0	.57	100	5	38
RO	0.000	3.7	.57	85	5	38
1	1.776	26.2	.58	0	5	39
2	2.176	26.0	.58	45	5	68
2	2.316	27.8	.58	35	5	68
2	4.031	46.3	.37	0	3	100
3	4.431	46.0	.52	36	5	93
3	6.212	60.0	.31	0	2	100
3	6.296	60.6	.31	0	2	100
3	8.049	71.2	.25	0	1	100
4	8.449	70.7	.40	26	3	100
4	9.537	76.7	.25	0	1	100
4	12.322	89.0	.17	0	0	100

gt5.0l: Fri Apr 17 '98 4.0

Test Title Feet Dnsy Alt Dry Dnsy Alt 60 ft Imprmnt ET Imprmnt MPH Imprmnt

gt5.0l: Fri Apr 17 98 10:43 am 1320 294 618 2.316 -.031 14.690 -.062 94.25 -1.63

gt5.0l: Fri Apr 17 98 3.5 1320 294 618 2.285 .016 14.628 -.045 95.89 .44

gt5.0l: Fri Apr 17 98 3.0 1320 294 618 2.301 .030 14.583 .040 95.45 .10

gt5.0l: Fri Apr 17 98 2.5 1320 294 618 2.331 .238 14.623 .526 95.35 .21

gt5.0l: Fri Apr 17 98 2.0 1320 294 618 2.569 15.149 95.14

Click on Test Title (1st column) to change it or to retrieve specs which produced those results. Click in other columns for definitions.

Edit the name here. In this case we changed the year to the axle ratio to record the modification.

Some History rows are blank because we Cleared History.

Figure 4.12 Test History of 7 Axle Ratios

Test Title	Feet	Dnsy Alt	Dry Dnsy Alt	60 ft	Imprvmnt	ET	Imprvmnt	MPH	Imprvmnt
gt5.0l: Fri Apr 17 98 5.0	1320	294	618	2.377	-.029	14.879	-.086	95.18	.83
gt5.0l: Fri Apr 17 98 4.5	1320	294	618	2.348	-.032	14.793	-.103	94.34	.09
gt5.0l: Fri Apr 17 98 4.0	1320	294	618	2.316	-.031	14.690	-.062	94.25	-1.63
gt5.0l: Fri Apr 17 98 3.5	1320	294	618	2.285	.016	14.628	-.045	95.89	.44
gt5.0l: Fri Apr 17 98 3.0	1320	294	618	2.301	.030	14.583	.040	95.45	.10
gt5.0l: Fri Apr 17 98 2.5	1320	294	618	2.331	.238	14.623	.526	95.35	.21
gt5.0l: Fri Apr 17 98 2.0	1320	294	618	2.569		15.149		95.14	

Click on Test Title (1st column) to change it or to retrieve specs which produced those results. Click in other columns for definitions.

Now go through the sequence of:

- Increasing the Final Drive Ratio by .5
- Calculating results
- Changing the time of day in the Test Title to the axle ratio just tested.

Once you have increased the axle ratio to 5.0, you will get a History Log that looks like Figure 4.12. Possibly to your surprise, the 3.0 ratio (close to the stock 3.08) is near optimum. You may then think "Why do drag cars have such low (high numerical) axle ratios?" Lets run these axle ratios again, with the GT5.0L set up for drag racing. Lets install slicks and drive more aggressively by changing the things identified in Table 4.1.

Table 4.1: Modifications To Set Up GT5.0L for "Serious" Drag Racing

Action on actual car	Modification in the program to simulate this action
Install 8" Slicks	Construction changed to Drag Slicks and Tread Width changed to 8 in the Wheel/Tires menu. (For now, lets assume the slicks are no "taller" or heavier than the original street tires, leave the Wheels/Tires Wt, lbs at 50 and Tire Diameter at 24.9.)
Aggressive Launch	Launch RPM changed to 5000 in the Driving Specs menu.
Power Shifts	Shift Time reduced to ".2 Fast" and Shift % Throttle increased to "100 Power Shifts" in the Driving Specs menu.

Figure 4.13 History for 7 Axle Ratios (GT5.0L Set Up for Serious Racing)

Test Title	Feet	Dnsy Alt	Dry Dnsy Alt	60 ft	Imprvmnt	ET	Imprvmnt	MPH	Imprvmnt
gt5.0l: Fri Apr 17 98 5.0	1320	294	618	1.936	-.011	13.802	-.073	96.25	.10
gt5.0l: Fri Apr 17 98 4.5	1320	294	618	1.925	-.001	13.729	-.016	96.15	-1.50
gt5.0l: Fri Apr 17 98 4.0	1320	294	618	1.924	-.006	13.713	.013	97.66	.60
gt5.0l: Fri Apr 17 98 3.5	1320	294	618	1.918	.010	13.726	.086	97.06	-.25
gt5.0l: Fri Apr 17 98 3.0	1320	294	618	1.928	.205	13.812	.384	97.30	1.85
gt5.0l: Fri Apr 17 98 2.5	1320	294	618	2.133	.328	14.196	.701	95.45	-.38
gt5.0l: Fri Apr 17 98 2.0	1320	294	618	2.461	-.485	14.897	-.838	95.84	-.60

Click on Test Title (1st column) to change it or to retrieve specs which produced those results. Click in other columns for definitions.

Figure 4.13 shows that lower (higher numerical) axle ratios *do* improve ET when the vehicle has enough traction to take advantage of the extra torque multiplication. Figure 4.13 shows the best ET of 13.713 occurs with gear ratio of 4.0.

Conclusions:

- The Drag Racing Analyzer allows you to easily maneuver between screens and menus with the click on a mouse.
- The program has several useful features like .001 Sec Increments (time) for improved accuracy, the Performance Summary and History Log to track you changes, and the Notes and Graphs to understand and analyze your performance.
- The Drag Racing Analyzer allows you to simulate "real world" modifications by simply typing in new specifications which simulate the hardware modification.
- Like most other vehicle settings, there is no single "best" axle ratio for the GT5.0L. The "best" ratio will change depending on other vehicle specs, for example like Tire specs which affect traction.

Example 4.2 Calibrating the Drag Racing Analyzer for Your Car

Features Introduced (and suggested background reading):

- Changing Calculate Performance Conditions (Section 2.7)
- Using Calculation Menus (Section 2.8)
- Adjusting specifications to match actual vehicle performance (Appendix 3)
- Using the Match Vehicle Performance Option (Section 2.9)

When using the Drag Racing Analyzer to predict the effect of modifications on a certain vehicle, it is best to first "calibrate" the program to match the vehicle's actual results. "Calibrate" means to fine tune an instrument (the Drag Racing Analyzer in this case) to improve its accuracy. Once the program is calibrated, its predictions are more likely to match your vehicle's response to modifications.

This example will be used as part of Example 4.3 also, which deals with predicting Bracket Racing "dial ins". Since these "dial ins" must be adjusted for minor changes in weather, we will use .001 Sec Increments, as also done in Example 4.1. Click on Preferences in the Main Menu and select .001 Sec Increments. You will notice the program warning you that the results may change slightly, because you are now asking for higher resolution time calculations.

We will calibrate the program for a 1971 Monte Carlo, with a 502 cubic inch big block and 400 Turbo Hydra-Matic. The car runs 10.12 ETs at 133.1 MPH. There are no vehicles in the Vehicle Library exactly like this, so we will have to build our own.

The 69-MACH1 is approximately the right size and is an automatic, but it is a production car. The SPR-STCK.V-6 is a 2 speed automatic with a V-6 engine, but is already set up for drag racing. We choose to start with the SPR-STCK.V-6 file. Once you are finished following Example 4.2, you should have a set of specifications which should match the file EXAMPLE4.2 in the Vehicle Library. (If we had chosen the 69-MACH1, calibrating would follow the same basic procedure, and the results would have been equally as accurate. You just have to change more specs.)

First, you must have results from a "good" run where you know the track conditions, like Table 4.2.

Next, open a fresh copy of the SPR-STCK.V-6 from the Vehicle Library by clicking on the Open button at the top left of the Main Menu as shown in Example 4.1. Enter the Monte Carlo's specs into the program as follows:

Table 4.3: 1971 Monte Carlo Running 10.12 @ 133.1 MPH

Critical Specs	Measured/Known Value	Drag Racing Analyzer Input
Weight w driver	3200	Vehicle Weight, lbs in Body & Axle Specs menu
Rear axle wt w driver	1400	% Wt on Rear Tires in Body & Axle Specs menu
Wheelbase	105	Wheelbase in Body & Axle Specs menu
Aerodynamic Cd	?	Drag Coefficient in Body & Axle Specs menu
Rear Axle Ratio	4.56	Final Drive Ratio in Body & Axle Specs menu
Engine displacement	502 cid	Displacement, CID in Engine specs menu
Converter	yes	Clutch/Tq Converter Type: Pick Example Converter
Transmission	Turbo Hydra-Matic 400	Transmission Type: Pick Example Transmission
1st shift RPM	7400	1-2 Shift RPM in Driving Specs menu
2nd shift RPM	7400	2-3 Shift RPM in Driving Specs menu
Rear Tires, 32 x 14 slicks	Drag Slicks	Rear Tire Construction Type: Drag Slicks in Wheels/Tires menu
Rear Tires, 32 x 14 slicks	32	Rear Tire Diameter in Wheels/Tires menu
Rear Tires, 32 x 14 slicks	14	Rear Tire Tread Width in Wheels/Tires menu
Rear Tires, traction	?	Rear Tire Traction Factor in Wheels/Tires menu
Track Conditions:		
Weather Instruments	Radio Weather Report	Method of Recording Weather Data: Radio/TV Weather Report with Dew Point
ET, 1/4 mile	10.12	
60 ft	1.48	
MPH, 1/4 mile	133.1	
Observed RPM, 1/4 mile	7200	
Observed Stall RPM	4500	
Barometric Pressure	29.46 **	Baro Pressure, "Hg in Calculate Performance Conditions menu
Air Temp (dry bulb)	83	Air Temperature in Calculate

		Performance Conditions menu
Wet Bulb Temp	73	Dew Point, deg F in Calculate Performance Conditions menu
Track Elevation	860	Elevation, ft in Calculate Performance Conditions menu
Wind Speed	5	Head Wind MPH in Calculate Performance Conditions menu
Headwind	5	Head Wind Direction: Headwind in Calculate Performance Conditions menu

** From your own weather station instrument, measuring actual (not corrected) barometric pressure.

Engine specs

Click on Engine specs at the Main Menu to display the current power specs for the Super Stock V-6. Change Displacement to 502. Then select the Method of Describing Power Curve which makes the most sense:

- If you had a complete dyno curve, you could pick Specified Full Curve and enter the dyno curve in the right hand section of this screen.
- You could pick an Example Power Curve and try to find something that you think would be close to your big block Chevy.
- If you know very little about the engine or power curves in general, it is probably best to pick Specified HP Only. This option lets the program decide the shape of the power curve. ***This is the one you pick.***

Now, to estimate the amount of HP coming from this engine, click on the Calc button by the Peak HP spec. You will see the Calculation Menu of Figure 4.14. Most all the input specs are disabled (dimmed to gray and they do not respond to inputs) except Type of Calc. Click on this combo box and select Quarter Mile MPH, because you know this but you do not know Eighth Mile MPH or you would have to estimate Vol Eff. Now several specs are enabled. They are loaded with values taken from the SPR-STCK.V-6.

For inputs to this menu, change Vehicle Weight from 2300 for the SPR-STCK.V-6 to the Monte's 3200 lbs. Enter 133.1 for Quarter Mile MPH. Assume your RPM

Figure 4.14 Calc. Menu for HP

Calc Power Curve

Peak HP 620.0

Peak Torque, ft lbs 519.0

Peak Torque RPM 5000

Performance Specs

Type of Calc Quarter Mile MPH

Vehicle Weight, lbs 3200

Quarter Mile MPH 133.1

Engine Cubic Inches 502

Vol Eff

RPM at HP Peak 6300

Notes:
This calculation will produce approximate power curve specs based on very simple inputs. It always uses the 'Std Dyno' Corr Factor. The 'Match Veh Performance' option is a more exact way to build a power curve based on more vehicle performance specs.

Use Calc Value Help Cancel

at HP Peak occurs a few hundred RPM before your shift points, for example 6900 RPM. Change the V-6's 7800 RPM to your estimate of 6900 for your Big Block Chevy.

The values in your calculation screen should now look like those in Figure 4.14. Click on Use Calc

Figure 4.15 Engine Specs with Modifications

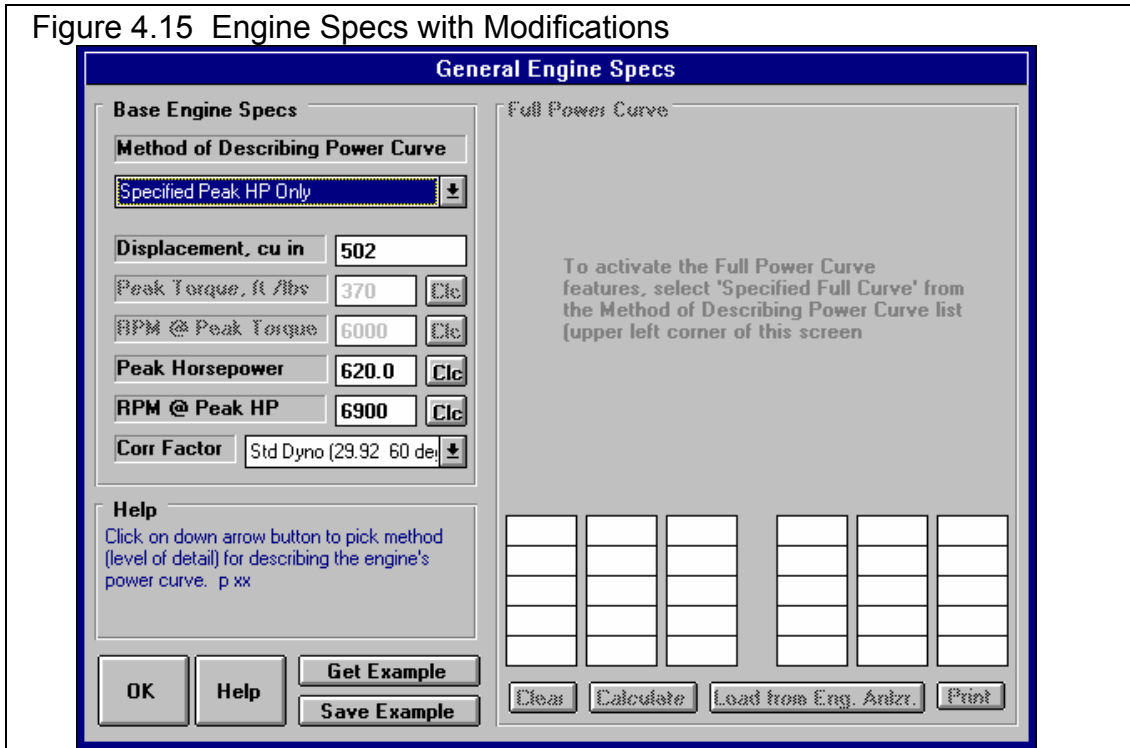

Value to load all the calculated values into the Engine Specs menu. The program asks if you want to use the 3200 lbs you entered here as the actual Vehicle Weight of this car, loaded in the Body & Axle menu. Since you do want to use it, answer Yes. Also notice (as said in the Notes of the Calculation Menu), the Power Corr is always set to Std Dyno (29.92 and 60 deg) after using this menu to calculate Power Curve specs. The General Engine Specs menu should now look like Figure 4.15.

Calculate Performance Conditions

Although it seems a little out of order to enter the Calculate Performance conditions now, the weather conditions in this menu are used for some torque converter calculations. So we will enter the Weather conditions now. Click on the Calculate Performance button. Before entering weather conditions, select the appropriate Method of Reading Weather Data.

You use your own barometer instrument which reads actual (not corrected) barometer and have a wet and dry bulb psychrometer for humidity. Click on the Method of Reading Weather Data and select Uncorr Baro and Rel Hum. There is no Wet and Dry Bulb Humidity option. Uncorr Baro and Dew Point would have been equally valid. You will have to calculate Rel Humidity from Wet and Dry bulb measurements by clicking on the Rel. Humidity's Clc button. Notice that Elevation becomes disabled since you barometer measures the actual air pressure, and an elevation correction is not needed.

Enter your barometer reading of 29.46 and the dry bulb reading of 83 for Air Temp. For Rel Humidity, click on the Clc button. Select No for Know Dew Point and Wet and Dry Bulb inputs become enabled, Dry Bulb already filled in with the 83 degree Air Temperature. Type in 73 degrees and press <Enter> to obtain the calculated 62% Relative Humidity. Click on Use Calc Value to load 62% back into the Calculate Performance Conditions menu.

Figure 4.16 Calc. Menu for Relative Humidity from Wet & Dry Bulb

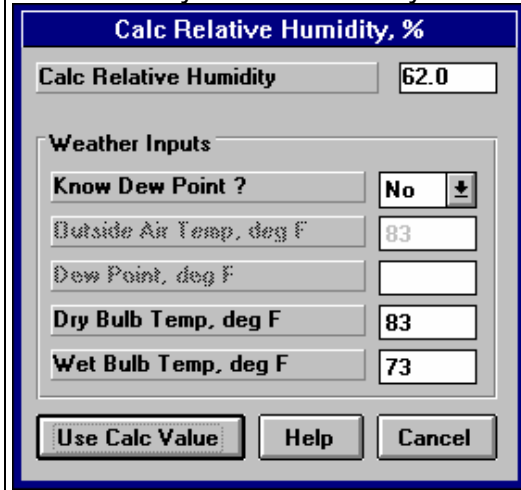

Next select Headwind as the Direction for Wind Specs, which enables Wind Speed where you enter the Wind Speed of 5 MPH. For Rollout, leave the SPR-STCK.V-6's selection of '10" medium' because you are not sure what your rollout is. Rollout is not critical if you just want to predict performance *changes*.

The Calculate Performance Conditions menu should now look like Figure 4.17. Click on Return to return to the Main Menu.

Figure 4.17 Calculate Performance Conditions

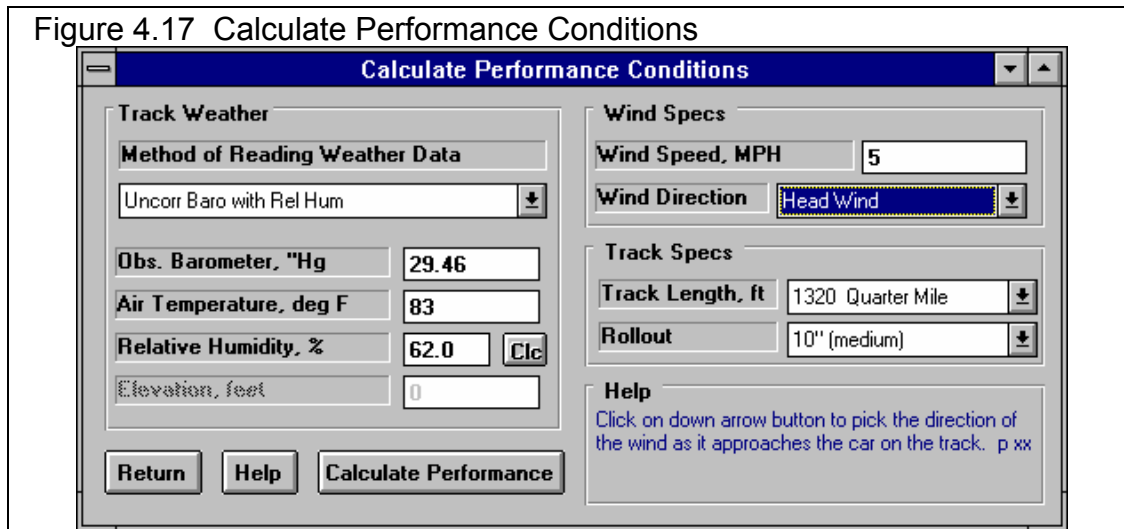

Transmission Specs

Click on the Transmission button menu at the Main for the Transmission Specs menu. For Clutch/Converter, the Type is already set to “Torque Converter: Use Specs Below”. You will see the clutch specs are disabled (dimmed to gray) indicating they are not used in the calculations.

You will notice the Converter Capacity was 385 for the V-6 and shows a 7480 RPM for the current Stall RPM. This makes sense since this was a loose converter for a higher RPM, lower torque producing engine. Now the converter has now been coupled with a high torque big block. Stall speed would be very high. You could pick an example converter or simply enter your known stall RPM of 4500 and press enter. The program responds that due to rounding in the calculations, the resulting Converter Capacity of 212.7 gives a Stall RPM of 4620. This is adequate for our purposes, because we can't read the tachometer that accurate anyway. For Torque Multiplication, we change the left over 1.7 from the V-6 to a more typical 2.0. (Notice how this Stall RPM is based on the current Power Curve and Track Weather Conditions, which is why we entered Weather Specs before going to the Transmission Specs.)

Click on the Transmission Type combo box and select Pick Example Transmission. From the list of transmissions, select the Auto-Turbo Hydra-Matic 400. Either double click on it to select it in one stroke, or click on it to highlight it, then click on the Pick button. You will next be presented with a

Figure 4.18 Picking the Example Turbo Hydra-Matic 400 Transmission

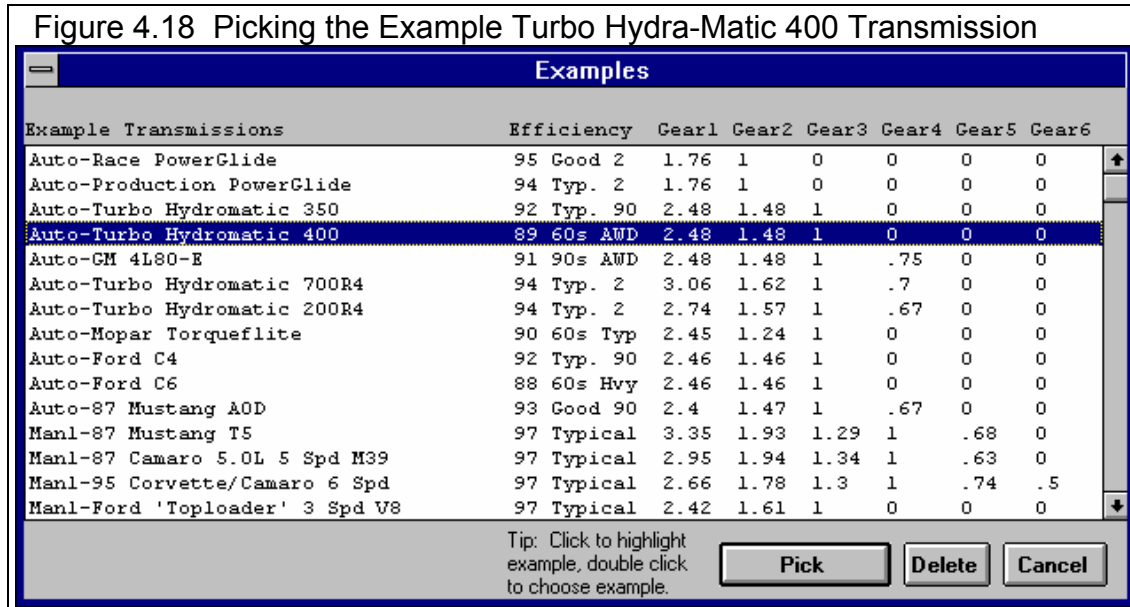

Example Transmissions	Efficiency	Gear1	Gear2	Gear3	Gear4	Gear5	Gear6	
Auto-Race PowerGlide	95 Good	2	1.76	1	0	0	0	
Auto-Production PowerGlide	94 Typ.	2	1.76	1	0	0	0	
Auto-Turbo Hydromatic 350	92 Typ.	90	2.48	1.48	1	0	0	
Auto-Turbo Hydromatic 400	89 60s AWD	2.48	1.48	1	0	0	0	
Auto-GM 4L80-E	91 90s AWD	2.48	1.48	1	.75	0	0	
Auto-Turbo Hydromatic 700R4	94 Typ.	2	3.06	1.62	1	.7	0	0
Auto-Turbo Hydromatic 200R4	94 Typ.	2	2.74	1.57	1	.67	0	0
Auto-Mopar Torqueflite	90 60s Typ	2.45	1.24	1	0	0	0	
Auto-Ford C4	92 Typ.	90	2.46	1.46	1	0	0	0
Auto-Ford C6	88 60s Hvy	2.46	1.46	1	0	0	0	0
Auto-87 Mustang AOD	93 Good	90	2.4	1.47	1	.67	0	0
Manl-87 Mustang T5	97 Typical	3.35	1.93	1.29	1	.68	0	0
Manl-87 Camaro 5.0L 5 Spd M39	97 Typical	2.95	1.94	1.34	1	.63	0	0
Manl-95 Corvette/Camaro 6 Spd	97 Typical	2.66	1.78	1.3	1	.74	.5	0
Manl-Ford 'Toploader' 3 Spd V8	97 Typical	2.42	1.61	1	0	0	0	0

Tip: Click to highlight example, double click to choose example.

Pick **Delete** **Cancel**

screen comparing the SPR-STCK.V-6's Powerglide transmission specs to the TH400's. Click on this screen's Load these Example Specs button. Then you will see a general description of the example transmission specs, and then you will be returned to the Transmission Specs menu with the TH400's specs loaded in. The Transmission Specs menu will now look like Figure 4.19.

Figure 4.19 Transmission Specs Menu

Clutch/Converter	
Type	Torque Converter, Use Specs Below
Clutch Diameter, in	10
Clutch Force, lbs	3333
# Clutch Disks	1
Clutch Material	Organic ("rag")
Converter Capacity	212.7
Conv Tq Multiplication	2
Converter Stall RPM based on Current Converter Capacity, Full Throttle Engine Power Curve and Weather Specs at the track	4620

Transmission	
Type	Ex Trans: Auto-Turbo Hydromatic 4L
Efficiency, %	89 60s AWD 3 & 4 spd Aut
First (1) Gear Ratio	2.48
Second (2) Gear Ratio	1.48
Third (3) Gear Ratio	1
Fourth (4) Gear Ratio	0
Fifth (5) Gear Ratio	0
Sixth (6) Gear Ratio	0

Help
Click on down arrow button to pick a type of clutch or torque converter. p 19

OK Help Get Example Save Example

Body & Axle

Click on Body & Axle at the Main Menu to open this menu. You'll see 3200 lbs already entered, from when we used 3200 lbs to calculate the HP based on quarter mile MPH. For Axle specs enter the Monte's 4.56, and leave the Diff Lock Eff at 100% Spool.

For Body Details, click on Type and select Pick Example Body Details. There are no Monte Carlos in the list, so select the closest match of Typical 60s/70s Intermediate. This will load several specs, but you will fine tune some to match your known measurements. First, click on the Clc button for % Wt on Rear to open its Calculation Menu. Enter the known weight of 1400 lbs for Weight on 1 Axle and select Rear for Which Axle. It calculates 43.8% as the Calculated % Wt on Rear Tires. Click on Use Calc Value to load it into the Body Details.

Figure 4.20 Body & Axle Menu

Section	Field	Value
Vehicle Weight	Vehicle Weight, lbs	3200
	Final Drive Ratio	4.56
Axle Specs	Diff Lock Eff. %	100% Spool
	Frontal Area, sq ft	22
Body Details	Type	Use Specs Below
	Driveline Layout	Rear Wheel Drive
	% Wt on Rear Tires	43.8
	Height of C.G., in	22
	Wheelbase, in	105
	Rear Track Width, in	50
	Frt Roll Stfns, %	No Frnt Sway Bar
	Drag Coefficient	.48
	Frontal Area, sq ft	22
	Final Drive Ratio	4.56

Also, type in your measured Wheelbase of 105 instead of the example's spec of 108, and measured Rear Track Width of 50 versus the examples 60. (The Monte's rear axle is narrowed to accommodate the 14" slicks.) In the process of changing these specs from the Examples, the program will warn you that the specs will no longer accurately represent the example, and the name will be changed to Use Specs Below. Select the Yes answer to the question "Change these specs anyway?" The Body & Axle menu should now look like Figure 4.20.

Wheels & Tires

For Front Wheel/Tire specs, you weigh a wheel and tire and come up with 20 lbs. The diameter you measure at about 22". You keep the Front Wheel/Tire Type of "Use Specs Below", and enter these measurements. (Actually, Front Wheel/Tire(s) specs are not that critical unless you are estimating a performance improvement by modifying Front Wheel/Tire weight or diameter. If the measurements were not available, you could have simply selected "Let Program Estimate" for the Type.)

For Rear Wheel/Tire Specs, select Pick Example Wheel/Tires from the list of Types. Select the Example Goodyear Superstock 32 x 14 Drag Slicks. The Wheel & Tire specs menu should now look like Figure 4.21.

Figure 4.21 Wheel/Tire Specs Menu

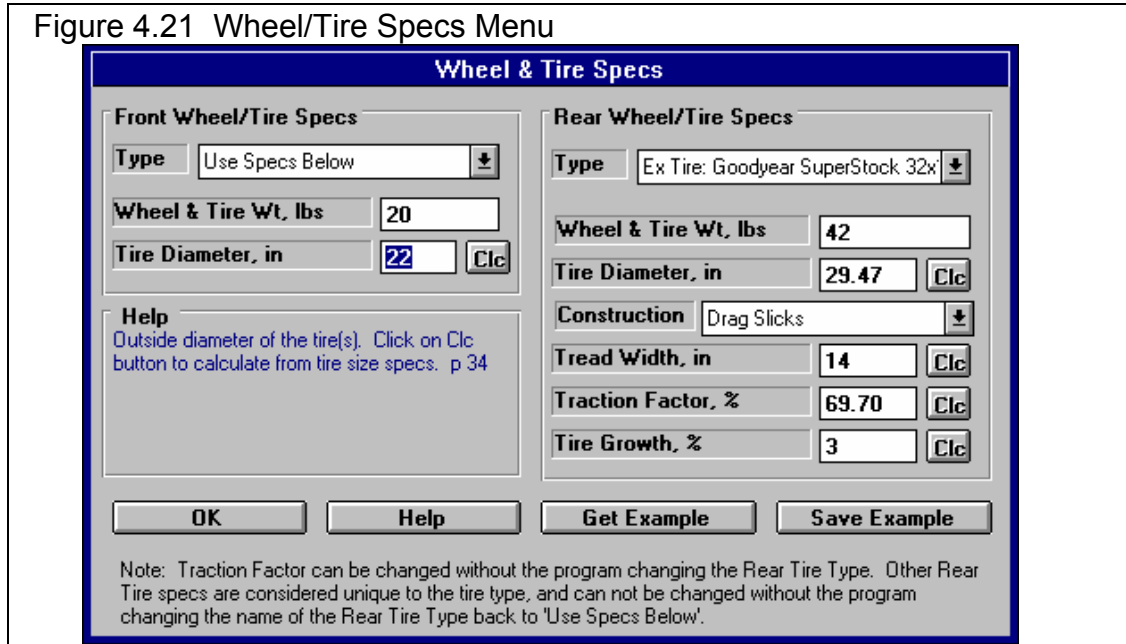

Driving Specs

At the Driving Specs menu, you see most of the specs are disabled indicating these values will not be used in the calculations. Leave the Launch Specs Type set to Computer Driven-No Tire Spin. This is the easiest way to get nearly optimum launches without having to constantly adjust the launch specs.

Also leave Shift Time at .4 Shift Kit as the SPR-STCK.V-6 was using. Set the 1-2 Shift RPM and 2-3 Shift RPM to your shift RPMs of 7400 for both. Driving Specs should now look like Figure 4.22.

At last, we've adjusted all specs as close as we reasonably can. Now return to the Main Menu and calculate Performance. You obtain an ET of 10.426, a MPH of 127.93 and a 60 ft of 1.510, all 3 which are close, but slightly slower than what you actually ran.

Figure 4.22 Driving Specs Menu

Driving Specs

Launch Specs

Type: Computer Driven-No tire spin

Launch RPM:

Launch % Clutch:

Launch % Throttle:

Launch Time, sec:

Help
Click on arrow button to pick type of launch from list p 38

Shift Specs

Shift Time, sec: .4 Shift Kit

Shift % Throttle: 50 Match RPM

Shift RPMs: Use RPMs below

1-2 Shift RPM:

2-3 Shift RPM:

3-4 Shift RPM:

4-5 Shift RPM:

5-6 Shift RPM:

Figure 4.23 Results for First Try

Drag Racing Analyzer v3.0 Performance Trends [SPR-STCK.-V6]										
Back Graph Print Analyze History Help(F1)										
Cmnts		Notes		Notes Summary: . Click on Notes for more Details.			Current: ET 10.426 MPH 127.93 Last: 10.440 127.53 Improvement: .014 .40			
Gear	Time	MPH	Accel Gs	Feet	C RPM	EngRPM	Tq Mult	C Slip	T Slip	% Thrt
1	-.189	.0	1.31	-1	0	4620	2.00	100	10	58
RO	.000	5.5	1.33	0	906	4674	1.77	81	10	58
1	1.510	45.9	.94	60	6798	7299	1.00	7	5	100
1	1.570	47.1	.90	64	6912	7400	1.00	7	5	100
2	1.622	48.1	.85	68	4189	5258	1.00	20	4	100
2	2.334	60.0	.66	125	4967	5699	1.00	13	3	100
2	4.249	84.8	.50	330	6721	7250	1.00	7	2	100
2	4.528	87.8	.47	365	6903	7400	1.00	7	1	100
3	4.580	88.3	.45	372	4687	5527	1.00	15	1	100
3	5.955	100.0	.35	563	5191	5862	1.00	11	1	100
3	6.602	104.9	.34	660	5427	6043	1.00	10	1	100
3	8.667	118.9	.28	1000	6069	6711	1.00	10	0	100
3	10.426	128.8	.23	1320	6519	7084	1.00	8	0	100
Test Title	Feet	Dnsy Alt	Dry Dnsy Alt	60 ft	Imprvmnt	ET	Imprvmt	MPH	Imprvmt	
spr-stck.-v6: Sun Apr 19 98 4:11 pm	1320	424	1083	1.510	.000	10.426	.014	127.93	.40	
spr-stck.-v6: Sun Apr 19 98 4:06 pm	1320	424	1083	1.510	.000	10.440	.030	127.53	.90	
spr-stck.-v6: Sun Apr 19 98 3:56 pm	1320	424	1083	1.510	.426	10.470	3.332	126.63	30.38	
gt5.0t: Fri Apr 17 98 5.0	1320	294	618	1.936	-.011	13.802	-.073	96.25	.10	
gt5.0t: Fri Apr 17 98 4.5	1320	294	618	1.925	-.001	13.729	-.016	96.15	-1.50	
gt5.0t: Fri Apr 17 98 4.0	1320	294	618	1.924	-.006	13.713	.013	97.66	.60	
gt5.0t: Fri Apr 17 98 3.5	1320	294	618	1.918	.010	13.726	.086	97.06	-.25	
Click on Test Title (1st column) to change it or to retrieve specs which produced those results. Click in other columns for definitions.										

Match Vehicle Performance Feature

The program is currently predicting your car runs slower than your actual car runs. We should fine tune these specs to get a better match between real time slips and what the program predicts. In previous versions of Drag Racing Analyzer and in other programs on the market, this would mean doing a lot of “cut and try”. Adjust a spec, see if you got a better match on, say 60 foot time. If you did, now did you “screw up” your MPH, ET, etc.

The solution is the Match Vehicle Performance option, available at the Main Menu. Return to the Main Menu from the Test Results screen of Figure 4.23. Click on the Match Veh Perf button at the top, to display the menu similar to Figure 4.24. Enter in your actual performance, including the engine RPM as you go through the traps (at the end of the quarter mile) of 7500 RPM. It should look like Figure 4.24. Then click on the OK (adjust veh. specs to match performance) button.

The program makes several passes adjusting critical specs between each pass, fine tuning the specs to find a combination which best matches your actual vehicle’s performance. After 20-30 passes, it arrives at the combination shown in Figure 4.25. At the top of this menu you see how close these new specs will make the performance match. In the lower section, you see the Old specs, and the new ones arrived at, which you can either Keep, or discard and return to the old specs. You see that the only New spec which is much different than the old specs in Engine Pk HP, which has increased from 620 to 704 HP.

Click on the Keep These New Specs button to keep these new specs.

Figure 4.24 Match Veh. Perf.

Match Vehicle Performance

Your Vehicle's Actual Performance

Distance of Race: Quarter Mile

Stall RPM at Launch: 4500

60 Foot Time, sec: 1.48

Finish MPH: 133.1

Finish Engine RPM: 7500

Finish Trans Gear #: 3

Tip: If you are not sure of 'Finish Engine RPM' or do not want tire diameter changed, just leave it blank or set it to 0. The program will not adjust tire growth or diameter to match this RPM.

Help
Click on down arrow button to select either Quarter or Eighth Mile run. p xx

Buttons: Help, Cancel, Clear Entries, OK (adjust veh. specs to match performance)

Figure 4.25 Results of Match Veh. Perf.

Modifications Required to Match your Performance

Performance from New Specs

	Conv Stall	60 ft	MPH	RPM	Gr
Specified Vehicle Perf	4500	1.48	133.1	7500	3
Perf Obtained from New Specs	4520	1.474	133.3	7443	3

Specs Which Have Been Changed

Spec Name	Old	New
Engine Pk HP	620.0	704.0
Eng Pk HP RPM	6900	7130
Converter Capacity	212.7	200.3
Rear Tire Diameter	30.0	29.47
Tire Construction Type	Drag Slick	Drag Slick
Tire Traction Factor	70	69.70
Tire Growth	3	3

Buttons: Keep These New Specs, Return to Old Specs

Note: The combination of specs arrived at by the Match Vehicle Performance feature are not necessarily the most accurate combination of specs to match your car.

The menu of Figures 4.24 and 4.25 are now gone. At the Main Menu, calculated performance and you confirm these specs *do* give results as stated by the Match Vehicle Performance screens, and that do match your car, just as shown in Figure 4.25. The ET of 10.081, which was not an input in the Match Vehicle Performance menu, also matches quite closely to your actual ET of 10.12.

Return to the Main Menu and click in the Vehicle Comments section and change them to match these specs for your 71 Monte Carlo. Figure 4.27 shows what you could type

Figure 4.26 First Screen for Saving Vehicle

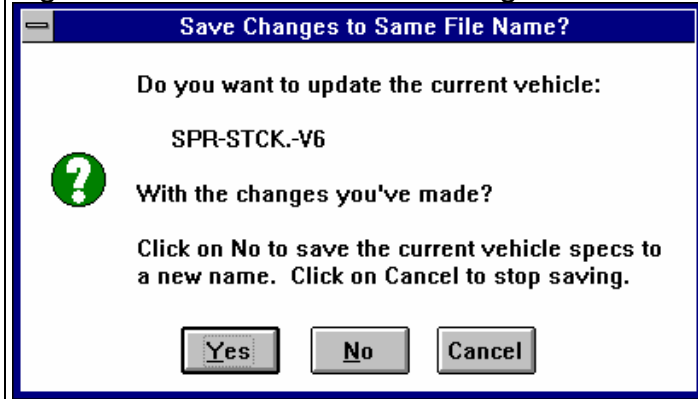
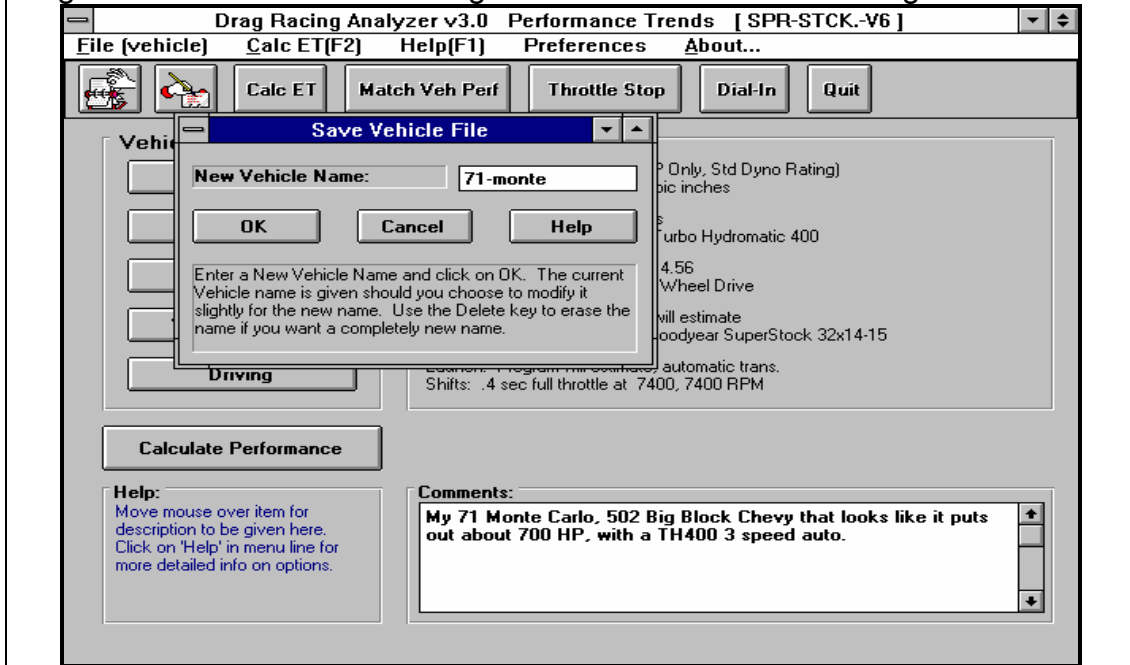

Figure 4.27 Screen for Entering New Vehicle Name for Saving



in for comments.

When finished, click on the Save button, or on File and then Save Vehicle. You are first as shown Figure 4.26. You answer No, since these specs no longer represent the SPR-STCK.V-6, but that you want to give it a new name. Next the screen shown in Figure 4.27 is displayed. Change the New Vehicle Name from SPR-STCK.V-6 to something that matches these specs, like MY-CAR or 71MONTE.

Now you are ready to check various modifications on your vehicle, like changing gear ratios, tire size, or shift points, etc. See Example 4.3.

Conclusions:

- After accurately entering specs, and then fine tuning them with the Match Vehicle Performance feature, the Drag Racing Analyzer's results can closely match the results of most any specific vehicle.
- The program has several options for entering specs, like picking example specs from preloaded lists, or by calculating them using Calculation menus from other known information or measurements
- You can make most any file from the Vehicle Library match your vehicle's specs following this procedure. Then you can save all these specs under a new name in the library for use at any time in the future.

Example 4.3 Predict Bracket Racing "Dial In"

Important: See Appendix 3, page 155, for new features in Version 3.2.

Features Introduced (and suggested background reading):

- Predicting detailed performance changes based on weather changes (Section 2.7)
- Dial In Prediction Menu (Section 2.11)

One place computers are widely used is in Bracket Racing, where the racer must accurately predict their ET before the race. This predicted ET is called the "dial in" and is used for setting starting handicaps. Example 4.3 will demonstrate how to use the Drag Racing Analyzer for determining your "dial in".

Matching Your Vehicle's Performance

The first step is to get the computer results to match your actual drag strip results. For Example 4.3, we will use the 1971 Monte Carlo file which was developed in Example 4.2. This file is in the Vehicle Library under the name EXAMPLE4.2, so click on the Open button (or Click on File and then Open) and open this file.

For your own vehicle, follow the procedure in Example 4.2 to match the Drag Racing Analyzer to your vehicle specs for some "good running" day. When the Drag Racing Analyzer's predicted results match your vehicle's results, save these specs to the Vehicle Library. Use a new vehicle name like "133-10.12" which could be for the your vehicle running 133.1 MPH in 10.12 seconds.

Note: .001 Sec Increments

Since we will be looking for very minor ET changes, we should select the .001 Sec Increments in the Preferences menu. This will have the program calculate all time results to the nearest thousandth of a second. This was done in Example 4.2. Calculate performance for the file EXAMPLE4.2 file and you obtain 10.081 @ 133.25 MPH.

Open Up Dial In Menu

Once you have developed a set of vehicle specs which represent your car, click on the Dial In button at the top of the Main Menu. ***These vehicle specs do not have to produce your ET and MPH exactly, but should be within a couple of MPH and a couple of tenths of the ET.*** You are first given a notice to this

effect as shown in Figure 4.28. Click on Yes and you will see a screen similar to that shown in Figure 4.29.

First, since you are starting a new sequence of runs at a new race, click on File and then New. This will blank out all the entries.

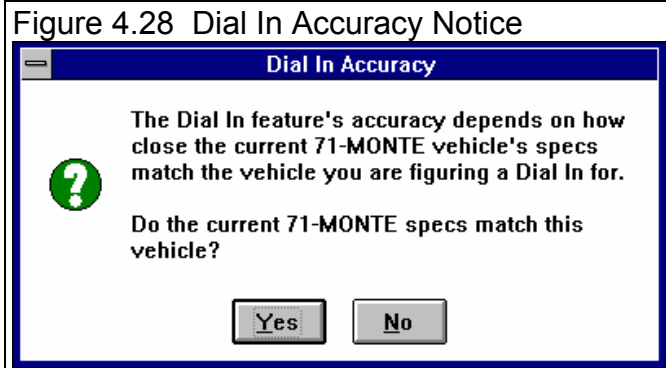
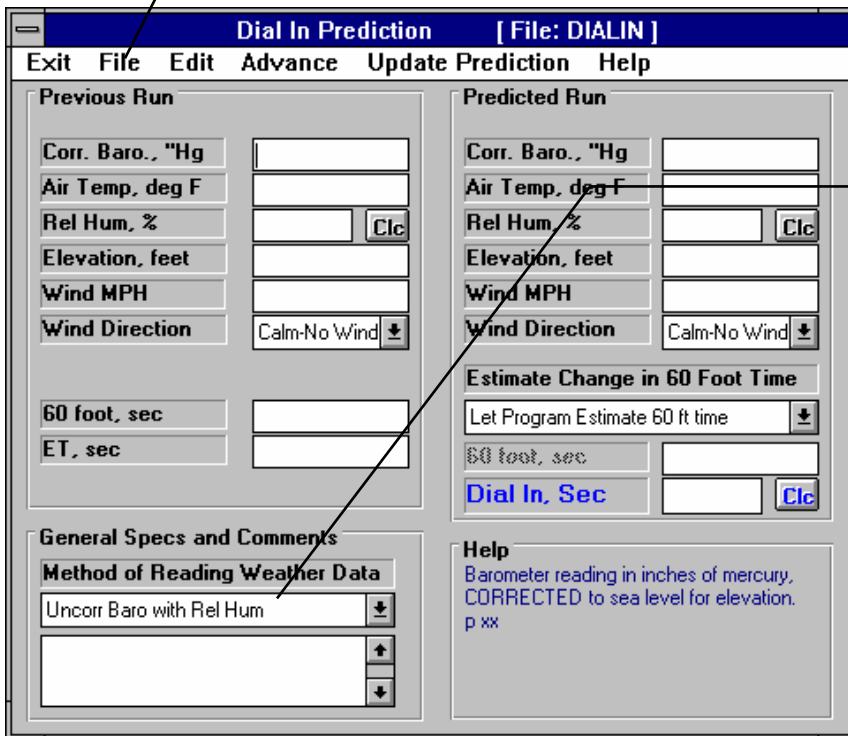

Figure 4.29 Dial In Menu

Click on File and then New to blank out all entries



Select the Method of Reading Weather Data which best matches your instrument package.

Next, obtain current weather conditions for the drag strip. For this example, we are using a commercial "Weather Station" package:

- A barometer instrument which reads our actual observed barometric pressure from 28" to 32" Hg.
- A dial thermometer for air temperature.
- A dial hygrometer which reads out in % Relative Humidity.
- Wind speed and direction you obtain from a hand held "wind speed meter and compass".

The Method of Reading Weather Data of "Uncorr. Baro and Rel. Hum." exactly matches your instrument package, so select it.

Load In a Practice Run

You make your first practice run, recording 10.150 at 134.2 with a 1.521 60 foot time. The weather for this run was:

- 28.56 " Hg
- 74 degrees
- 72 % relative humidity
- 14 MPH tail wind (helping push the car down the track)

Enter this data into the Dial In menu for the Previous Run as shown in Figure 4.30. You are now ready to start predicting future runs.

Predict Dial In

For your first round, you measure the weather as:

- 28.79 " Hg
- 81 degrees
- 66 % relative humidity
- 7 MPH tail wind (helping push the car down the track)

The weather specs for both the Practice (Previous) run and the Predicted run are shown in Figure 4.30. The program predicts a 10.187 ET or "Dial In" based on your first run and the change in weather. This is what the program predicts the car will run, but you may *not* want to use this number for your Dial In, "as is", but subtract off a safety factor.

Figure 4.30 Dial In Menu

The screenshot shows the 'Dial In Prediction' window with the following data and callouts:

Previous Run		Predicted Run	
Obs. Baro., "Hg	28.56	Obs. Baro., "Hg	28.79
Air Temp, deg F	74	Air Temp, deg F	81
Rel Hum, %	72	Rel Hum, %	66
Elevation, feet		Elevation, feet	
Wind MPH	14	Wind MPH	7
Wind Direction	Tail Wind	Wind Direction	Tail Wind
60 foot, sec	1.521	Estimate Change in 60 Foot Time	
ET, sec	10.15	Let Program Estimate 60 ft time	
		60 foot, sec	1.506
		Dial In, Sec	10.187

Callouts and their descriptions:

- Enter weather conditions for an known, Previous Run, like a practice run. (Points to Previous Run weather fields)
- Enter ET and 60 foot time for this Previous Run (Points to Previous Run 60 foot and ET fields)
- Enter weather conditions for your Predicted or Dial In Run. (Points to Predicted Run weather fields)
- Optional (not shown here): You can enter your estimate of the 60 foot time for the Dial In Run. (Points to Predicted Run 60 foot field)
- Click on Clc button to determine your Dial In. (You may want to adjust it to prevent a "break out". (Points to the Clc button next to the Dial In, Sec field)

This safety factor would prevent you from "breaking out" should the car run slightly quicker than the predicted ET. You will have to use your judgment based on your competition for the safety margin you need. If you have good competition, you will have to risk breaking out and use a small safety factor, for example .005 seconds. If your competition is poor, use a larger factor, for example .03 seconds. Subtract this safety margin from the Predicted Dial In for your actual "dial in". For example, with stiff competition your "dial in" would be:

$$\text{"Dial In"} = 10.187 - .005 = 10.182 \text{ seconds}$$

Note: The Safety Margin is now a separate input in Version 3.2. See Appendix 3, page 155

You will notice in Figure 4.30 there is a spec directly above the Dial In box called Estimate Change in 60 Foot Time. In this example, we let the program estimate how 60 foot time would change. When you choose this, the program basically assumes traction will stay the same, and any change in 60 foot time is due to more or less engine power due to changes in air conditions. It assumes the tires and track have the same traction as the Previous run.

However, let say you believe that you will run a .030 second quicker 60 foot time than on the Previous run. This may be due to one lane being stickier than another, or other changes in the track conditions. Under this condition, a better choice for Estimate Change in 60 Foot Time may be "You enter (predict) 60 ft time below". Then the spec 60 Foot Time for the Predicted run becomes enabled, and you can enter your estimate of what the 60 foot time would be.

Next Run

Assume you win your first round. For the next round's Dial In, click on the Advance command at the top of the Dial In menu as shown in Figure 4.31. The program will copy all the weather information from the Predicted Run to the Previous Run and leave the Predicted run blank. Fill in your actual ET and 60 foot time for this last run. Assuming you ran 10.193 with a 1.528 60 foot time, fill in these values. Then fill in the weather for the next round into the Predicted Run column. When finished, click on the

Figure 4.31 Dial In Menu After Using the Advance Command

The screenshot shows the 'Dial In Prediction' window with the following data:

Previous Run	Predicted Run
Obs. Baro., "Hg: 28.79	Obs. Baro., "Hg: [Blank]
Air Temp, deg F: 81	Air Temp, deg F: [Blank]
Rel Hum, %: 66 [Clc]	Rel Hum, %: [Blank] [Clc]
Elevation, feet: [Blank]	Elevation, feet: [Blank]
Wind MPH: 7	Wind MPH: [Blank]
Wind Direction: Tail Wind [v]	Wind Direction: [Blank] [v]
60 foot, sec: [Blank]	Estimate Change in 60 Foot Time: Let Program Estimate 60 ft time [v]
ET, sec: [Blank]	60 foot, sec: 1.506
	Dial In, Sec: [Blank] [Clc]

Annotations:

- Click on Advance to move Predicted weather conditions to Previous Run
- Predicted Run is blanked out
- ET and 60 foot time are blanked out for you to enter your actual numbers.

Click button by Dial In or the Update Prediction command. The new predicted Dial In is 10.265 as shown in Figure 4.32. This is how you will proceed, advancing the Predicted Run's weather and actual ET and 60 foot time to the Previous Run, and coming up with new Dial Ins through the rounds.

Figure 4.32 Dial In Menu Predicting Dial In for the Next Round

The screenshot shows the 'Dial In Prediction' window with a menu bar (Exit, File, Edit, Advance, Update Prediction, Help) and a title bar ([File: DIALIN]). The window is divided into several sections:

- Previous Run:** Obs. Baro., "Hg: 28.79; Air Temp, deg F: 81; Rel Hum, %: 66; Elevation, feet: (empty); Wind MPH: 7; Wind Direction: Tail Wind; 60 foot, sec: 1.528; ET, sec: 10.193.
- Predicted Run:** Obs. Baro., "Hg: 28.84; Air Temp, deg F: 85; Rel Hum, %: 64; Elevation, feet: (empty); Wind MPH: 8; Wind Direction: Side Wind; Estimate Change in 60 Foot Time: Let Program Estimate 60 ft time; 60 foot, sec: 1.506; Dial In, Sec: 10.265.
- General Specs and Comments:** Method of Reading Weather Data: Uncorr Baro with Rel Hum.
- Help:** Observed barometer reading in inches of mercury, as read directly off a barometer instrument (not corrected to sea level for elevation). p xx

Annotations with arrows point to specific elements:

- Top right: 'Fill in your actual 60 ft time and ET.' (points to the 60 foot, sec field in the Previous Run section).
- Middle right: 'Fill in the weather for the next round.' (points to the weather fields in the Predicted Run section).
- Bottom right: 'Click on the Clc button to calculate the new Dial.' (points to the Clc button next to the Dial In, Sec field).

Conclusions:

- The Drag Racing Analyzer can make detailed ET predictions based on changes to weather conditions.
- The Dial In menu makes calculating Dial Ins for Bracket Racing convenient.
- Using .001 Sec Increments (instead of .01 Sec Increments in the Preferences menu) lets the program make ET and Dial In predictions in thousandths of a second.

Example 4.4 Predict Throttle Stop to Run Index

Important: See Appendix 3, page 155, for new features in Version 3.2.

Features Introduced (and suggested background reading):

- Example 4.2 and 4.3
- Throttle Stop, Section 2.10
- Track Weather Specs, Section 2.7.2

This example is very similar to Example 4.3 except, instead of predicting your ET, you must change your throttle stop setting to run a specified ET. Like a Dial In, you will record weather conditions and ET for a previous run (in this case 2 runs) and input weather conditions for a future run to Predict. Instead of telling you the ET the car will run for this Predicted Run, the program tells you how to set your throttle stop to run your desired ET.

Matching Your Vehicle's Performance

The first step is to get the computer results to match your actual drag strip results. See Example 4.2 for this. For this example we will use the Super Gas Grand Am vehicle SG-GRAND.-AM. Open this file from the Vehicle Library. This car runs about 9.68 ETs with no throttle stop. The throttle stop is used to slow it down to running the 9.90 index of the NHRA Super Gas class.

Open Up Dial In Menu

Once you have developed a set of vehicle specs which represent your car, click on the Throttle Stop button at the top of the Main Menu. ***These vehicle specs do not have to produce your ET and MPH exactly, but should be within a couple of MPH and a couple of tenths of the ET.*** You are first given a notice to this effect as shown in Figure 4.33. Click on Yes and you will see a screen similar to that shown in Figure 4.34.

First, since you are starting a new sequence of runs at a new race, click on File and then New. This will blank out all the entries.

Next, you will need 2 Previous or practice runs. *These are very important and must be obtained with 2 very different throttle stop settings. The throttle stop settings must produce at least a .3 second difference in ET.*

The throttle stop setting is usually the time the stop is On (or has the throttles closed) you set on the throttle stop timer. This usually has the finest control and best repeatability.

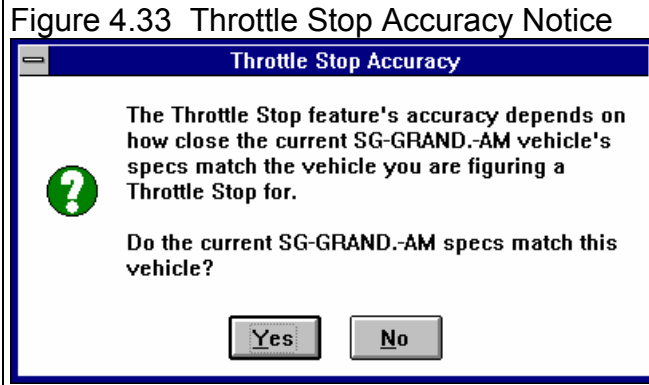

Figure 4.34 Throttle Stop Menu

Click on File and then New to blank out all entries

Select the Method of Reading Weather Data which best matches your instrument package.

Enter your desired ET (Index + any safety

Enter the time the throttle stop first comes

The screenshot shows the 'Throttle Stop Prediction' window with a menu bar (Exit, File, Edit, Advance, Update Prediction, Help) and a title bar ([File:]). The interface is divided into several sections: 'Previous Run' with columns for Run 1 and Run 2; 'Predicted Run'; 'General Specs and Comments' with a dropdown for 'Method of Reading Weather Data' and a text field for 'Index, sec' (containing 9.91); and a 'Help' section. Annotations with arrows point to the 'File' menu, the 'Method of Reading Weather Data' dropdown, the 'Index, sec' field, and the 'Throttle Stop' button in the 'Predicted Run' section.

General Specs and Comments

Method of Recording Weather Data: For this example, we are using:

- An altimeter, which is corrected to 29.92" mercury
- A mercury thermometer for air temperature
- A dial hygrometer which reads out in % Relative Humidity.
- Wind speed and direction you obtain from a hand held "wind speed meter and compass".

The Method of Reading Weather Data of "Altimeter and Rel. Hum." exactly matches your instrument package, so select it. Note that the Barometer input is disabled. You will enter your altimeter reading as Altimeter in feet of altitude.

Your throttle stop timer is set to come on 3 seconds after the trans brake releases, so enter 3 for T/S Start Time.

You are running in the 9.90 index class. However, instead of typing in the 9.90 index, you type in 9.91 to give yourself a .010 second safety margin for breaking out. If you run too quick, you "break out" and loose. Should your car run up to .010 seconds faster than you expect, you still will not break out.

Load In 2 Practice Runs

Recommended Steps for Recording Previous Runs

Previous Run #1: The first run can be made with a very short throttle stop setting, perhaps only .2 seconds On. Based on your experience, we make run with the throttle stop timer set for .75 seconds and record the weather, 60 foot time, ET and the throttle stop setting.

Previous Run #2: The second run must produce at least a .3 second increase in ET. Ideally, it will produce an ET approximately equal to or slightly slower than your desired or Index ET. Again based on your experience, adjust the throttle stop timer to be on for say 1.5 seconds. Make a run like this, and record the weather, 60 foot time, ET and the throttle stop setting.

It is critical that the difference in the throttle stop settings for these 2 Previous Runs produce at least a .3 second difference in ET.

Fill in the data for these 2 Previous Runs as shown in Figure 4.35.

Predict Throttle Stop

For your first round, the air continues to improve. You measure the weather as:

- 1415 feet altitude or Elevation
- 75 degrees
- 68.6 % relative humidity
- 7 MPH side wind

The weather specs for both the Previous runs and the Predicted run are shown in Figure 4.35. For this round, you are getting the left lane, which everyone is complaining is .02 seconds slower for 60 foot times. Knowing this, you select “You enter (predict) 60 foot time below” for “Estimate Change in 60 Foot Time”, and enter 1.425, which is about .02 seconds slower (longer) than your Previous Run 60 foot times.

Click on the Clc button by Throttle Stop, and the program recommends you use a 1.333 second throttle stop setting. Enter this number into your throttle stop timer. Remember, because you’ve already added

Figure 4.35 Dial In Menu

Enter weather conditions, throttle stop settings, 60 foot times and ETs for 2 known, Previous Runs. The 2 different throttle stop settings (time throttle plates are closed) must produce at least a .3 second difference in ET.

Enter weather conditions for your Predicted or Dial In Run.

Optional: You enter your estimate of the 60 foot time for the Predicted Run.

Click on Clc button to determine the Throttle Stop setting to produce your Index ET.

Previous Run		Run 1	Run 2	Predicted Run	
Obs. Baro., "Hg		29	29.07	Obs. Baro., "Hg	29.3
Air Temp, deg F		88	77	Air Temp, deg F	75
Rel Hum, %		46.7	64.1	Rel Hum, %	68.6
Elevation, feet		1539	1472	Elevation, feet	1415
Wind MPH		11	9	Wind MPH	7
Wind Direction		Side Wind	Side Wind	Wind Direction	Side Wind
Throttle Stop		.75	1.95	Estimate Change in 60 Foot Time	
60 foot, sec		1.405	1.401	You enter (predict) 60 ft time below	
ET, sec		9.76	10.12	60 foot, sec	1.425
General Specs and Comments				Throttle Stop	1.333
Method of Reading Weather Data	Index, sec			Clc	
Altimeter with Rel Hum	9.91				
	T/S Start Time				
	3				

Note: Throttle Stops for Run 1 and Run 2 must produce ETs that are at least .3 seconds different.

Help
The approximate time from the release of the trans brake or clutch pedal until the throttle stop comes on. This gives the program a general idea if the throttle stop comes on early or late in the run. p xx

in a safety factor of .010 seconds, you do not need to adjust the 1.333 seconds for a safety factor. Use the 1.333 seconds exactly.

Note: The Safety Margin is now a separate input in Version 3.2. See Appendix 3, page 155

Next Run

Assume you win your first round with a 9.905 ET. For the next round's Throttle Stop prediction you are tempted to use your latest run to help predict a new throttle stop. However, because the difference between Previous Run #1 and your latest run is less than .3 seconds ($9.905 - 9.760 = .145$), *the accuracy would not be good and the program recommends you do not do it*. Actually, the program will not even calculate a Throttle Stop setting for the Predicted run if the ETs for the Previous run are not at least .2 seconds or more. So, from now on, simply enter the new weather conditions for each round into the Predicted Run. Enter your estimate of 60 foot time, or let the program estimate it, and set the new Throttle Stop setting on your timer for the new weather conditions.

Conclusions:

- The Drag Racing Analyzer can predict a throttle stop setting to run a certain ET (Index) under changing weather conditions, based on 2 previous runs with different throttle stop settings which produce at least .3 seconds difference in ET.
- Using .001 Sec Increments (instead of .01 Sec Increments in the Preferences menu) lets the program make 60 foot, ET and Throttle Stop predictions in thousandths of a second.

Important: See Appendix 3, page 155, for new features in Version 3.2 which make Throttle Stop Predictions easier.

Appendix 1: Accuracy and Assumptions

Background:

The Drag Racing Analyzer was developed as a:

- Tool to help predict effects of certain engine and vehicle modifications for engine builders, drag racers, and performance enthusiasts.
- "Theoretical Drag Strip" to allow anyone to try things which are too expensive, difficult, dangerous, or impossible with a real vehicle.
- Learning aid for those who want to better understand vehicle dynamics during full power acceleration.

The Drag Racing Analyzer will provide you an engineering estimate of what should occur when general modifications are made based on the principles of vehicle dynamics and physics. By seeing all the specifications which go into the calculated results, you may have a false sense that the computer knows your vehicle exactly; what manufacturer's torque converter you are using, who built the chassis, what your 4 link settings are, etc. Actually the computer does not know if the specifications are for a production Yugo or a Record Holding Funny Car.

A good analogy to the Drag Racing Analyzer is a flow bench. A flow bench can not predict exact torque and HP curves, but is still a vital tool for engine development. In the same way, use the Drag Racing Analyzer results as a guide or second opinion of how your vehicle should perform under near optimum conditions.

Iterations

Before we talk about accuracy, it is important for you to understand the types of calculations going on inside the Drag Racing Analyzer and other sophisticated simulation programs. A simple program could involve calculating quarter mile MPH from HP and vehicle weight:

$$\text{Quarter Mile MPH} = K1 \times \left[\frac{\text{Engine HP}}{\text{Vehicle Weight}} \right]^{K2}$$

You enter an engine HP and Vehicle Weight and obtain a quarter mile MPH value. The answer you obtain on the left side of the equation has no effect on the inputs on the right side of the equation.

However, lets look at a simplified version of the equation which the Drag Racing Analyzer uses just to calculate the maximum potential tractive force (traction) the tires can produce.

$$\text{Max Tractive Force} = \text{Tire Friction} \times (\text{Wt on Rear Tires} + \text{Wt Transfer})$$

Where: Wt Transfer depends on the vehicle's acceleration rate which depends on the tires Max Tractive Force.

In this case the "Max Tractive Force" answer you get on the left side has an effect on the inputs to the equation on the right. The only way to solve equations like this is through "iterations". Iteration is a process where you assume an answer, use that answer in the right side of the equation, calculate the actual answer and see if the actual answer is "close enough" to the answer you assumed.

Iteration Process:

(For this example we will not use actual numbers since the calculations are quite complex)

Assume Max Tractive Force is 3000 lbs

Calculate that the vehicle acceleration could be .8 Gs and the Wt Transfer value is 600 lbs

Using the Wt Transfer of 600 lbs, we now calculate that the Max Tractive Force is 3200 lbs

Are assumed Max Tractive Force and calculated Max Tractive Force "close enough" (within 20 pounds)

No, so do again using new Max Tractive Force answer

Calculate that the vehicle acceleration could be .85 Gs and the Wt Transfer value is 640 lbs

Using the Wt Transfer of 640 lbs, we now calculate that the Max Tractive Force is 3218 lbs

Are assumed Max Tractive Force and calculated Max Tractive Force "close enough" (within 20 pounds)

Yes, so an approximate answer is: Max Tractive Force = 3218 lbs

If "close enough" was 200 lbs, our first answer of 3200 lbs would have been good enough. If "close enough" was 1 lb, it may require many more calculations to arrive at an answer which is "close enough". If the equation is very complex and the inputs are an unusual combination, no answer may be reached no matter how many times the calculation is performed. This is called "not converging on a solution".

Making the tolerance ("close enough") small will produce more exact answers but will require more calculation time. Performance Trends has selected tolerance bands for iterations which give good accuracy with reasonable calculation times, and allow the process to "converge on a solution".

Because many of the equations within the Drag Racing Analyzer must be solved by iterations, there is no one exact answer. All calculations are an approximation. Therefore, do not be alarmed if an ET improvement of .002 seconds is shown for changing in Dew Point from 67 to 66, but changing from 66 to 65 showed a .004 second improvement. These results are basically saying lowering the Dew Point results in a very small gain in ET.

Other Vehicle Simulation Programs

Other vehicle simulation programs are available which do not use nearly as many inputs as the Drag Racing Analyzer uses. At first you may think these other programs are "smarter", since they do not need this additional inputs.

However, each input the Drag Racing Analyzer uses has an effect on performance, for example Wind Direction and Wind Speed. The other programs either are making an assumption that wind is some set value, or assume it has no effect. By letting you adjust Wind Direction and Speed, the Drag Racing Analyzer shows you:

- The change in performance due to a change in Wind conditions
- Allows you greater accuracy, since you specify the wind conditions, and do not rely on the program's assumed conditions.

Major Assumptions

To make the Drag Racing Analyzer and the specifications which describe the vehicle containable on a personal computer, several simplifying assumptions are made which are listed below. Other approximations and assumptions exist as identified in Section 1.3 A Word of Caution and scattered throughout this manual. Also see Assumptions in the Index.

- All vehicle components are assumed to be perfectly stiff, which means:
 - There is no delay in engine torque getting to the tires due to driveshaft, axle or tire "wrap up".
 - There is no "pitch rotation" of the vehicle (front lifting, rear dropping) due to the suspension's springs or shocks.
 - There is no change in the Height of CG due to "pitch rotation" or the body lifting.
- Engine torque changes instantaneously with a change in throttle position. In real engines, torque changes are delayed from .1 to .5 seconds or longer from throttle changes.

- The torque converter's performance is typical of production, 3 element, hydrodynamic torque converters. Actual converters (especially those significantly modified) can have performance characteristics that can be quite different than production converters.
- Clutch holding torque does not change with time, temperature or clutch wear.

Accuracy

From reading the assumptions above and scattered throughout this manual, it is obvious several important aspects of vehicle performance are "glossed over". Therefore, it is impossible to make exact predictions of what will happen to your vehicle when modifications are made.

It should be possible to adjust the Drag Racing Analyzer to match your vehicle's performance (see Example 4.2 and Appendix 3) to agree with your vehicle's results within .03 seconds at all points on the track. However, even after this, a modification may not be simulated completely accurately.

For example, you specify a higher stall converter and the program predicts a 4800 RPM stall and a .1 second ET improvement. You install the converter and obtain the 4800 RPM stall speed predicted by the Drag Racing Analyzer. However, the converter exhibits more high speed slip (due to a poor design) than what the Drag Racing Analyzer assumes and your actual ET drops .1 second. The program is still accurate based on its assumptions, its just that your parts do not fit its assumptions.

.001 Sec Increments

Increasing the time resolution (choosing .001 Sec Increments in the Preferences menu) tells the program to do the calculations in much smaller time steps. This does improve the mathematical accuracy somewhat. However, it does not increase the program's overall accuracy significantly. This is primarily due to the program's assumptions and tolerance bands for iterations remaining the same.

To summarize, we believe the Drag Racing Analyzer is the most precise and detailed software for predicting acceleration performance available to drag racers in this price range. However, it's predictions can differ from your vehicle's results. This is primarily due to the assumptions made by the program, and other points raised in this Appendix.

Appendix 2: "General Tips"

The following "tips" will show you how to change the Drag Racing Analyzer calculations by adjusting various inputs.

Calibrating "Tips"

Calibration is the process of adjusting the program's inputs to produce results which closely match a certain vehicle's drag strip results. Example 4.2 shows this process in some detail.

Start with a file from the Vehicle Library which somewhat closely resembles your car. Then, modify all inputs you can measure or know for certain. Also, choose "Computer Driven-no tire spin" as the Launch Type in the Driving Specs menu to let the computer launch the car.

There are other specifications which you probably do not know or are difficult to measure. These uncertain specs which will have a major impact on performance include:

"Uncertain" Specifications

- Engine Power Curve specs (unless dynamometer data is available)
- Clutch Specs for manual transmissions
- Converter Capacity for automatic transmissions
- Transmission Efficiency
- Tire Growth
- Drag Coefficient
- Tire Traction Factor
- Shift Time

Use the guidelines in Sections 2.2 - 2.7 and Example 4.2 to estimate the "uncertain" specs. Calculate performance and compare the computer's results to your car's actual results. Use actual results from a "good running" day, and results you feel comfortable you could repeat under the same conditions. Then use the "tips" below bring the computer's results in line with these actual results.

To increase the MPH, with little effect on ET

- Reduce Drag Coefficient
- Increase Tire Growth
- Increase Engine Power Curve specs *and* decrease Traction Factor

To decrease ET and 60 ft times, with little effect on MPH

- Increase Traction Factor
- Adjust Converter Capacity (stall RPM) for automatic transmissions
- Adjust Converter Torque Multiplication for automatic transmissions
- Increase Launch RPM for manual transmissions
- If Bog (engine RPM dropping too low) is a problem, try reducing Clutch Force for manual transmissions
- If traction is not a problem, increase Clutch Force (or other clutch specs which produce more torque holding capability)

To increase ET and 60 ft times, with little effect on MPH

- Reduce Traction Factor
- Choose Use Specs Below for the Launch Type in the Driving Specs and use the launch specs to simulate your actual launch

To decrease ET and increase MPH, with little effect on 60 ft time

Leave Tire Traction and other tire specs “as is” and:

- Increase Engine Power Curve specs
- Increase Clutch Force, lbs for manual transmissions, especially if CSlip is high in gears other than 1st gear
- Increase Efficiency in the Transmission Specs menu
- Decrease Shift Time in the Driving Specs menu

To decrease ET and decrease MPH

- Increase Converter Capacity for automatic transmissions

To increase ET with little effect on MPH or 60 ft time

- Increase Shift Time
- Decrease Shift % Throttle for manual transmissions
- Choose some “less than optimum” shift RPMs in the Driving Specs menu.
- Change the shape of the HP curve.

Another Tip

By adjusting Shift RPMs, you can simulate most any acceleration. For example, let's say you want to know the time to accelerate from 50 MPH to 80 MPH in 3rd gear. Adjust the 2-3 SHIFT RPM until the vehicle starts 3rd gear (after the 2-3 shift) at exactly 50 MPH. Then adjust the 3-4 SHIFT RPM until the vehicle starts the 3-4 shift at exactly 80 MPH. The time between start and end of 3rd gear is 3rd gear's 50-80 MPH time.

Using Dynamometer Data for Engine Power Curve Specs

Engine Power Curve specs are discussed in Section 2.2. Dynamometer tests which measure engine performance can be done in different ways. How the test is done can over-estimate or under-estimate the engine's torque and HP in the vehicle.

The Drag Racing Analyzer works best if you enter steady state dynamometer results, with the engine equipped exactly as it will be in the vehicle. "Equipped" means with the full exhaust and intake system, all accessories running like water pump, fan, etc. "Steady state" means that engine RPM is stable (not changing) when the torque and HP are measured. This is sometimes called a “step test”.

Accelerating dynamometer tests, where the engine speed is constantly increasing (i.e. 300 RPM/sec), can under-estimate an engine's steady state performance. You may think an accelerating test best represents an engine accelerating in a vehicle. However, the Drag Racing Analyzer calculates the power loss due to accelerating the engine, which changes in each gear. See "Inertia" discussion in this Appendix.

Rotating Inertia

The difference between stationary and rotating mass is important for a racer to understand. Ever racer knows that the less a car weighs, the faster it can accelerate. However, not every racer knows that removing 30 lbs from the

vehicle's rotating components (wheels, tires, engine flywheel) will show a larger improvement in accelerating performance than removing 30 lbs from the frame or body.

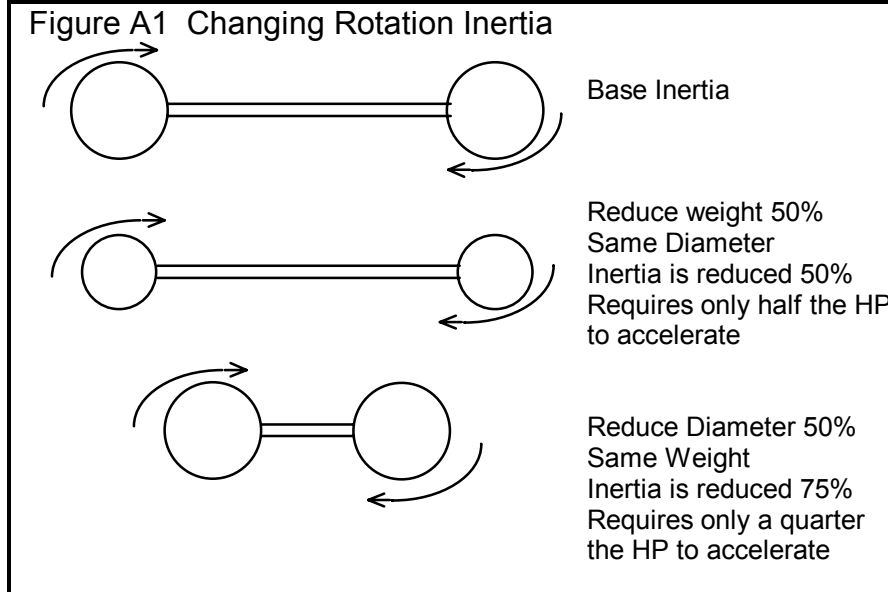

This is because not only do you have to accelerate the tires down the quarter mile, you have to get the tires to spin faster also. The spare tire in the trunk is easier to accelerate than the same tire mounted on the axle. The tire on the axle has both mass *and* rotational inertia.

Rotational inertia is a part's resistance to changing its rotational speed. Jack up the axle and try to spin the wheel. Neglecting friction, a heavier wheel requires more force to spin than a light wheel. In addition, if the mass is concentrated in the tire and less in the wheel, it will require even more force to spin. That is because rotational inertia depends on mass and the distance the mass is from the center of rotation. See Figure A1.

For this reason, rotating components with small diameters, which concentrate the mass close to the center of rotation, have much less inertia. These components consist of the driveshaft, axle shafts, etc. Reducing the weight of these components insignificantly reduces you rotating inertia. Rotating components with larger diameters (flywheel or torque converter, wheels/tires, somewhat in the crankshaft, damper and transmission components) contain most of the vehicle's rotating inertia. These are the components to concentrate on when trying to reduce rotating inertia. ***For example, removing 1 pound from the engine's flywheel will have 100 up to 1000 times or more effect on the vehicle's rotational inertia than removing 1 pound from an axle shaft.***

Example

Try some examples with the Drag Racing Analyzer with the GT5.0L. The GT5.0L's Baseline performance is a 14.593 ET.

Now, remove 40 lbs from the front wheels by setting Front Wheels/Tires WT = 10 instead of 50. This modification simulates moving 40 lbs from the front wheels and placing it somewhere on the body, since we did not also reduce Vehicle Weight 40 lbs. (If you have the Preference "Warn on Tire Weight Change" selected, the program will ask you if you want to change the vehicle weight by 80 lbs when you leave the Wheels/Tires menu. Answer No for now.) Calculate performance and we get an ET of 14.512. Nearly a one tenth improvement just by moving weight around on the vehicle (not moving it to change traction).

Now reduce the Vehicle Weight 80 lbs to 3120. This simulates removing 40 lbs from each front wheel & tire *and* not placing it on the vehicle. This GT5.0L's ET is now down to 14.441.

Condition	Analyzer Modification	ET	MPH
Baseline	No change to GT5.0L	14.593	94.97
Remove 40 lbs from each front wheel/tire and place the weight on the body	Front Wheel/Tire Weight = 10	14.512	95.34
Remove 40 lbs from each front wheel/tire (vehicle weight lightens up 80 lbs)	Front Wheel/Tire Weight = 10 Vehicle Weight = 3120	14.512	95.34

(To be exact about removing 40 lbs from each front wheel/tire, the GT5.0L's % Wt on Rear Tires would have increased to 41% from the GT5.0L's original 40% Weight on the Rear.)

Engine Inertia

Engine inertia is more complicated than other rotating inertia on the vehicle. It is not always best to reduce engine inertia to improve acceleration.

That is because the engine is not "geared" directly to the road. Engine RPM does not have to change at the same rate, or even in the same direction as vehicle speed. When the vehicle's speed is zero, the engine could be spinning at 10,000 RPM. Release the clutch and the engine RPM drops as the vehicle speeds up.

Because of this difference, you can use the engine's rotating inertia to help accelerate the car. For example, an engine's flywheel spinning a 10,000 RPM stores tremendous energy. This energy can be used to get the vehicle accelerating once you drop the clutch. The flywheel also releases stored energy during shifts, when engine RPM drops from the high speed of the previous gear to the lower speed in the next gear.

The Drag Racing Analyzer estimates the rotational inertia of the engine and clutch/flywheel or converter and transmission parts based on:

- Displacement in the Engine Specs menu (the higher the displacement, the higher the inertia)
- Clutch Specs like # disks, diameter, clutch force (the higher these specs, the higher the inertia)
- Converter Capacity (the higher the capacity, the lower the inertia because this usually means a smaller diameter converter)

Tips on Simulating Modifications

The previous "inertia" examples point out an error most users will make. When you make a modification, always think of how it could affect each specification. The example of removing 40 lbs from the front wheels not only affected Front Wheels/Tires WT, but also Vehicle Weight and % Wt on Rear Tires. Below is a list of common modifications and the specs they may affect.

Engine Modifications

Engine modifications can change all Engine Power Curve specs and Displacement. If the engine is naturally aspirated (not supercharged, turbocharged or uses nitrous oxide) and you increase the HP, generally the RPM where the HP will peak will increase also. Vehicle Weight and % Wt on Rear Tires may also change if you change to aluminum components (less weight) or add a supercharger (more weight), etc.

Adding, Removing or Shifting Weight

- Vehicle Weight
- % Wt on Rear Tires
- Front & Rear Wheels/Tires Weight

Changing vehicle height

- Height of CG
- Frontal Area, sq ft

Changing wheels and tires

- All the Wheels/Tires Specs
- Vehicle Weight, lbs
- % Wt on Rear Tires
- Track Width
- Frontal Area, sq ft

Changing torque converter

- Converter Capacity
- Conv Tq Multiplication
- Vehicle Weight

Appendix 3: New Features in Version 3.2

Here is a brief listing of some of the features new in Version 3.2:

- Program is now a 32 bit version, fully compatible with newer operating systems, starting with Windows, 95, then 98, Me, XP, and 2000. This also allows you to use much longer, more descriptive file names for saving vehicles, throttle stop data and dial in data. It is also more compatible with newer printers.
- The program is now designed for 600 x 800 or higher resolution screens.
- There is now a separate “Examples” folder for example vehicle files provided by Performance Trends. New vehicles which you save will be saved to a separate folder of Your Saved Vehicles.
- A new Preference lets you remove the Performance Trends Example Vehicles from Your Saved Vehicles if you have updated from Version 3.0.
- There are now File commands to save a vehicle file to a floppy disk, or open a vehicle file from a floppy disk. This makes it easy to copy a vehicle file from one computer to another.
- You can now choose to list vehicle, dial in and throttle stop files alphabetically (as normally done) or by saved date, with the most recently saved files listed first. This should make it easier to find recent files more quickly.
- You can now choose to only list vehicle files which have certain words or phrases in their names, like just “Chev” files, “Import” files or “Race” files. This should make it much easier for you to find example vehicles or your vehicles in a long list.
- The user’s manual is now available from inside the program by clicking on Help at the top of the main screen, then Display User’s Manual. The manual is in a high quality PDF format
- The Performance Trends website is now available from inside the program by clicking on Help at the top of the main screen, then Performance Trends on the Web.
- A Print button and Windows Print Setup button (or menu option) have been added to many screens to let you print these individual screens.
- An Optimize button has been added at the top of the Main Screen, which lets you instantly find the best torque converter (if transmission is an automatic) or final drive (rear axle) ratio for quickest ET.
- Two new calculation menus have been added, one to convert engine size from CCs or Liters to cubic inches, and the other is to estimate the vehicle weight of your car based on some popular car models.

- The recent results section of the results screen now includes 60 ft time and the improvement for the current and previous run.
- A summary Time Slip, similar to what you get at the drag strip, is available in the results screen for the current results, and available for any of the 25 runs in the history log.
- Commands in the History Log have been updated and streamlined. Now when you click on a row in the History Log, you are now presented with 4 command options, Open, Rename, Help or Time Slip.
- The Dial In and Throttle Stop screens have a new spec of "safety margin", which the program uses to give you a margin of error to keep you from breaking out.
- The Throttle Stop Predictions can now be based on just one previous run, and an Adjustment Factor from a previous run. This Adjustment Factor is obtained by doing a calibration run at some previous time. See the detailed explanation later in this section for this more convenient method of predicting throttle stops.
- The program will now "Auto Link" to our upcoming Engine Analyzers, versions 3.2. Auto Linking means the Engine Analyzer screen will show the resulting MPH and ET from an engine change, running the Drag Racing Analyzer program completely in the background.
- A new Preference lets you obtain instant updates of ET, MPH and 60 ft times from every change you make in the vehicle specs screens. This can be a great time saver, especially on newer, faster computers.
- Several new Example Vehicle Files have been added, to make building your vehicle easier.

Figure A2 New Features in Results Screen

60 ft times now included in "Improvement" section.

The screenshot shows the Drag Racing Analyzer v3.2 Performance Trends [10SEC-FW.D] interface. At the top, there are menu options: Back, Graph, Print, Analyze, History, Time Slip, and Help(F1). Below the menu is a 'Notes Summary' section with a 'Notes' icon and text: 'Notes Summary: Very High Clutch Slip. Tire Traction Very Low. Click on Notes for more Details.' To the right of the notes, there are performance statistics: Current: ET 10.855 MPH 131.07 60 ft 1.822; Last: 12.244 113.02 1.910; Improvement: 1.389 18.05 .088.

The main data table has columns: Gear, Time, MPH, Accel Gs, Feet, C RPM, Eng RPM, Tq Mult, C Slip, T Slip, % Thrt. The table contains 15 rows of data, with the last row being 4, 10.855, 132.07, .26, 1320, 6643, 6643, 1.00, 0, 0, 100.

A 'Time Slip' dialog box is open, showing: Mon Oct 21 02 8:37 am, Time Slip For: 10SEC-FW.D, and a list of performance metrics: RT .500, 60 ft 1.822, 330 ft 4.773, 1/8 ET 7.135, 1/8 MPH 107.39, 1000 ft 9.138, 1/4 ET 10.855, 1/4 MPH 131.07. There are 'Close (back)' and 'Print' buttons at the bottom of the dialog.

At the bottom of the screenshot is a 'History Log' table with columns: Test Title, Feet, Dnsy Alt, Dry Dnsy Alt, 60 ft, Imprvmt, ET, Imprvmt, MPH, Imprvmt. The table contains 8 rows of data. A context menu is open over the first row, with options: Open (retrieve these specs), Show Help Describing This Column, Rename Test, and Show Time Slip.

Drag Strip Time Slip available by clicking on Time Slip (for current results) or run from the History Log.

Click on any row from the History Log to be presented with these options. The Open option lets you retrieve the specs which produced these results, a very handy method of returning to a combination which produced better results. (This feature was available in v3.0)

Figure A3 Throttle Stop Screens

Throttle Stop Prediction [File: THRTLSP]

Exit File Edit Options Advance Update Prediction Help

Previous Run Use Two Previous Throttle Stop Runs
 Use One Previous Throttle Stop Run
 Current T.Stop Factor = 24.368
 Help Using 1 T.S Run

Corr. Baro., "Hg: 29.13
 Air Temp, deg F: 75
 Dew Point, deg F: 63
 Elevation, feet: 670
 Wind MPH: 7
 Wind Direction: Side Wind

Throttle Stop: .75
 60 foot, sec: 1.405
 ET, sec: 9.76

60 Foot Time: 60 ft, sec
 Let Program Est. 60 ft tir: 1.405
 Safety Margin, sec: 0
 Throttle Stop: 1.381

Adj. Factor: 24.368

General Specs and Comments
 Method of Reading Weather Data: Radio/TV Report with Dew Pt
 Index, sec: 9.9
 T/S Start Time: 2.5

Help
 Barometer reading in inches of mercury, CORRECTED to sea level for elevation. p 50

This screen is as described in manual, basing throttle stop on 2 previous runs.

Select "Use Two" (old method) or "Use One" T/S. For Use One, you must have an "Adj Factor" from a previous set of runs. See test for how to use each method.

"Adj Factor" and "Safety Margin" added in V 3.2.

Throttle Stop Prediction [File: THRTLSP]

Exit File Edit Options Advance Update Prediction Help

Previous Run

	Run 1	Run 2
Corr. Baro., "Hg	For Run 1, enter the Adjustment Factor below from a previous set of runs.	29.07
Air Temp, deg F		77
Dew Point, deg F		63
Elevation, feet		670
Wind MPH		9
Wind Direction		Side Wind
Throttle Stop	Adjust Factor: 24.368	1.95
60 foot, sec		1.401
ET, sec		10.12
Adj. Factor		24.368

Predicted Run

Corr. Baro., "Hg: 29.13
 Air Temp, deg F: 75
 Dew Point, deg F: 63
 Elevation, feet: 670
 Wind MPH: 7
 Wind Direction: Side Wind

60 Foot Time: 60 ft, sec
 Let Program Est. 60 ft tir: 1.405
 Safety Margin, sec: .01
 Throttle Stop: 1.410

General Specs and Comments
 Method of Reading Weather Data: Radio/TV Report with Dew Pt
 Index, sec: 9.9
 T/S Start Time: 2.5

Help
 Barometer reading in inches of mercury, CORRECTED to sea level for elevation. p 50

New screen for using "One T/S" with an "Adj. Factor" from a previous set of runs.

Enter the "Adj Factor" from a previous set of Calibration runs, where you made a large change in the throttle stop setting. Now a Predicted Run's throttle stop setting is just based on Run 2's results and this "Adj Factor".

New Throttle Stop Options:

In Version 3.2, there are 2 ways to predict Throttle Stops:

1. Based on 2 previous runs obtained during time trials or “test and tune runs”. This is the only method that was available in version 3.0, is somewhat more accurate but much less convenient.
2. Based on 1 run and the "Adjustment Factor" determined from some set of 2 runs you ran some previous time. This method has been added in Version 3.2 and is much more convenient.

Click on Options at the top of the Throttle Stop screen, and then select which method you want to use.

To determine the correct Adjustment Factor for one run, you must first open a throttle stop file you have run in the past which has 2 runs. Then click on the "Clc" button by the Predicted Throttle Stop setting or click on "Update Prediction". When there is a Predicted Throttle Stop displayed, you will also notice an “Adj Factor” or Adjustment Factor displayed under Run 2.

Now you can click on Options and choose “Use One Previous Throttle Stop Run”. The screen will change, and the “Adj Factor” will be loaded in. You could also simply type in a adjustment factor from a previous set of runs. Also enter the weather, TS setting, ET and 60 ft for just one previous run (Run #2). Now the program is ready to predict a new Throttle Stop setting from new weather conditions you enter for Predicted Run. Click on the “Clc” button by the Throttle Stop output, or the Update Calculation menu item for the Throttle Stop setting you should run.

For example, you have obtained an “Adj Factor” of 25.234 based on 2 previous runs, perhaps 2 months ago. You come to a new event and make a time trial pass with certain weather conditions, throttle stop setting and ET. This first time trial should be your attempt to run very close to the Index. You enter these conditions into the program as Run 2. Now, for your Round 1 run, you enter the current weather conditions, Safety Margin, and method to estimate the 60 ft time for the Predicted Run and click on the “Clc” button to obtain the correct Throttle Stop setting. This Throttle Stop setting will be nearly as accurate as if you had made 2 runs with very different throttle stop settings as described in the manual in Example 4.3.

You will also notice a new input called “Safety Margin”. For example, if you say your index is 9.90, but you want the program to predict what setting is necessary to run a 9.93 (a .03 second safety margin), you should enter 9.90 as the Index and .03 as the Safety Margin. Safety Margin is also available in the Dial In screen and works in a similar way.

What is “Adj Factor”?

The Adjustment Factor is a measure of how much affect your throttle stop has on your vehicle’s ET. It is measured by making 2 different runs with 2 *very* different throttle stop settings, say one where the throttle stop is on for .5 seconds, and another where the stop is on for 2.5 seconds. These are not runs where you will try to run your index, and are best run during a “test and tune” session. Your objective is

to produce 2 very different ETs, hopefully .300 to .600 seconds different than each other. These 2 runs should be done with no other vehicle changes, and ideally with very little difference in the weather conditions. Take the weather conditions and results for these 2 runs and load them into the Throttle Stop screen as Run 1 and Run 2. Put in most any conditions for the Predicted Run and click on the “Clc” button to update the Throttle Stop Prediction and you will be given the “Adj Factor” for Run 1 and Run 2.

This “Adj Factor” can now be used for predicting Throttle Stop settings. If you make significant changes to the vehicle, throttle stop settings or the time the throttle stop comes on (say it was 1.5 seconds into the run, now it is 2.5 seconds into the run), you must obtain a new “Adj Factor” based on 2 runs with very different throttle stop settings with this new change.

Figure A4 New Calculation Menus

Vehicle Weight Estimator is available for Vehicle Weight input at the Vehicle Specs screen.

Displacement Calculator is available for Displacement in the Engine Specs screen.

Calc Displacement, cu in

Calc Displacement, cu in 73.22

Metric Displacement

Enter Displacement In? CCs

Engine Displacement 1200

Use Calc Value Help Cancel Print

Est Vehicle Weight

Est Vehicle Weight 3550

Vehicle Specs

Year 1970

Make Chevrolet

Model Camaro

Engine Small Block V-8

Transmission Manual

Convertible No

Additional Weight

Driver Weight 180

Gallons of Fuel 5

Note:
A good match was found.

Use Calc Value Help Cancel Print

Note new Print buttons

Figure A5 New Features at Main Screen

The screenshot shows the main interface of Drag Racing Analyzer v3.2. The top menu bar includes File (vehicle), Calc/ET, Help, Preferences, and Reg To: Kevin Gertgen. The 'File' menu is open, showing options like New, Open Example Vehicle from Performance Trends, Open One of My Saved Vehicles, Save Vehicle, Save As, Open from Floppy Disk, Save To Floppy Disk, Print Main Screen, Print Blank Worksheet, Windows Printer Setup, Unlock Program, and Exit Program. A callout box points to the 'Open Example Vehicle from Performance Trends' option, stating: "Open either Examples from Performance Trends or vehicles you saved to your separate library". Another callout points to the 'Open from Floppy Disk' and 'Save To Floppy Disk' options, stating: "Options to save to or open from floppy drive, making it easy to move vehicle files from one computer to another." A third callout points to the 'Unlock Program' option, stating: "Unlock lets you turn the demo into a working version with a code #." A fourth callout points to the 'Save To Floppy Disk' option, stating: "Click here to set default floppy drive letter (A or B)." A fifth callout points to the 'Allow Instant Updating of Changes' option in the Preferences menu, stating: "Click on Allow Instant Updating of Changes for feature described on next page." A sixth callout points to the 'Remove Old Example Vehicles from Your Vehicles' option, stating: "If updating from v3.0, click here to remove old example vehicle files from Your Saved Vehicles folder. New Examples with same specs are in Examples folder." A seventh callout points to the 'Display the User's Manual (with v3.2 Supplement)' and 'Display the the Readme.doc file (recent changes)' options, stating: "Options to display the user's manual or the Readme.doc file listing recent changes." An eighth callout points to the 'Other Performance Trends Products' and 'Performance Trends on the Web' options, stating: "Click here to visit the Performance Trends website to read about or download demos of other products, or updates on this product." The Preferences menu is also open, showing options like Default Floppy Drive, currently A, .01 Sec Increments: (runs faster), .001 Sec Increments (more exact), Beginner Level, Experienced Level, Remind On Tire W/t Change, Don't Remind on Tire W/t Change, Engine Graph - Thick Lines, Engine Graph - Thin Lines, Allow Instant Updating of Changes, Don't Allow Instant Updating of Changes, and Remove Old Example Vehicles from Your Vehicles.

Open either Examples from Performance Trends or vehicles you saved to your separate library

Options to save to or open from floppy drive, making it easy to move vehicle files from one computer to another.

Click here to set default floppy drive letter (A or B).

Click on Allow Instant Updating of Changes for feature described on next page.

Click here to find best axle ratio or converter.

Unlock lets you turn the demo into a working version with a code #.

If updating from v3.0, click here to remove old example vehicle files from Your Saved Vehicles folder. New Examples with same specs are in Examples folder.

Options to display the user's manual or the Readme.doc file listing recent changes.

Click here to visit the Performance Trends website to read about or download demos of other products, or updates on this product.

Figure A6 Instant Updating of Results

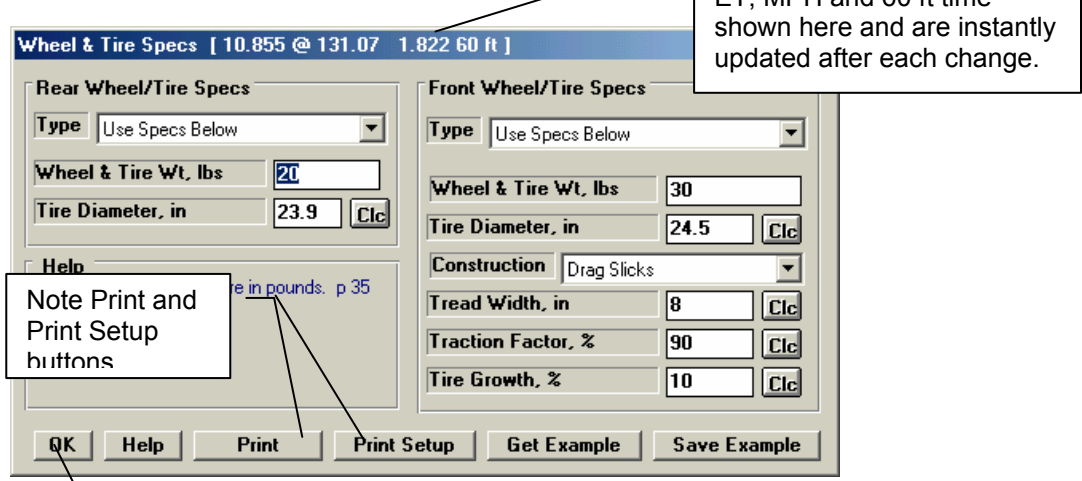

ET, MPH and 60 ft time shown here and are instantly updated after each change.

Note Print and Print Setup buttons

If using this feature, it is best to always close out each screen by clicking on the OK button, then going to the next screen. If you simply click on an option on the main screen while another screen is open, the program can "get confused" and may drop some of the specs you have changed.

Figure A7 Open Screen Features

This is the normal way the screen would look, as it would in Version 3.0.

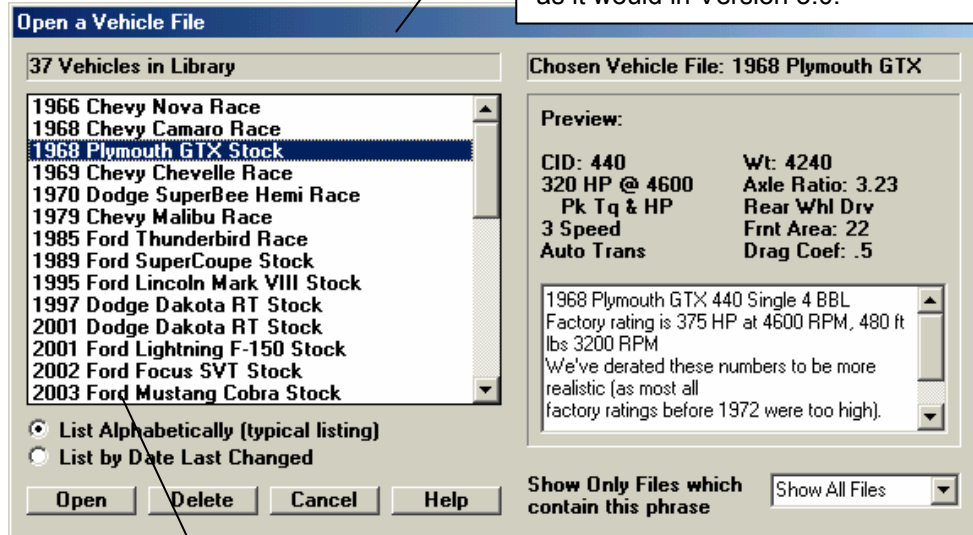

Note the use of much longer, more descriptive file names available in Version 3.2.

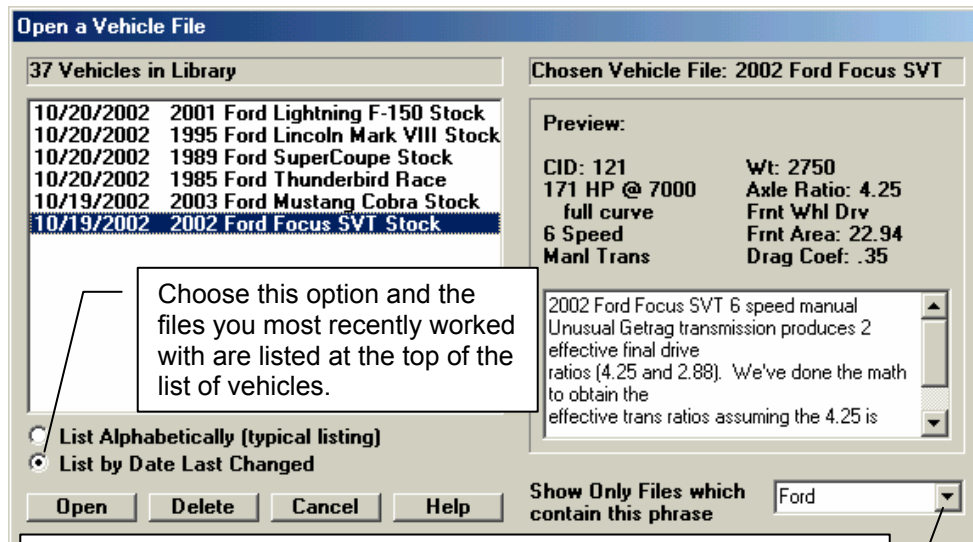

Choose this option and the files you most recently worked with are listed at the top of the list of vehicles.

Pick a phrase to look for in the name of the file to be listed (like "Ford" shown here), or choose "Show All Files" to show all files in the library, or type in most any phrase of your choosing.

Appendix 4: New Features in Version 3.4

Here is a brief listing of some of the features new in Version 3.4:

- Allows for a graphics file to be included with your vehicle data. This graphics file can be printed separately or with your printouts. At this time, only JPG files can be added.
- More Vista and Windows 7 compatible.
- Program now better remembers Printer Changes and Printer Type.
- Better at finding more and newer versions of Acrobat and Reader Preferences now has a global switch turn off Intro Help Tips
- InstantCalc Results (ET & MPH for each modification you make as they are made by the user) are now shown on Main screen in Blue, if selected in Preferences. Prior to v3.4, InstantCalc results were only displayed in the individual Component screens.
- Did fine tuning of Tire Diameter and Tire Tread Width calculations to better match the new, modern P Metric tires with very tall and wide wheels.
- New Preference lets you select to do new "Fine Tuned" method for calculations for P metric tire sizes on not.
- Program now better finds Engine Analyzer programs to link up with.
- Added some more example transmissions.
- Fixed a minor bug where a file size would never shrink if you changed to a smaller size JPG pic file.
- Added many new example vehicle files with pictures.
- Screen for saving files now has much larger field for entering long names.

Figure A8 Including a Graphics File with the Vehicle File

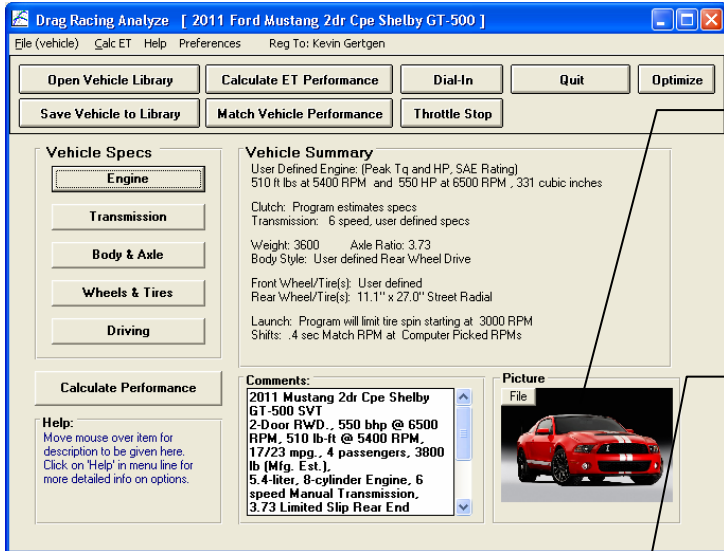

Picture size gets adjusted as the screen is resized for various computer screens or display modes.

Click on File button to remove the picture, insert a different picture, or print the picture. To change printer settings, click on File at upper left corner of this main screen, then Windows Printer Setup.

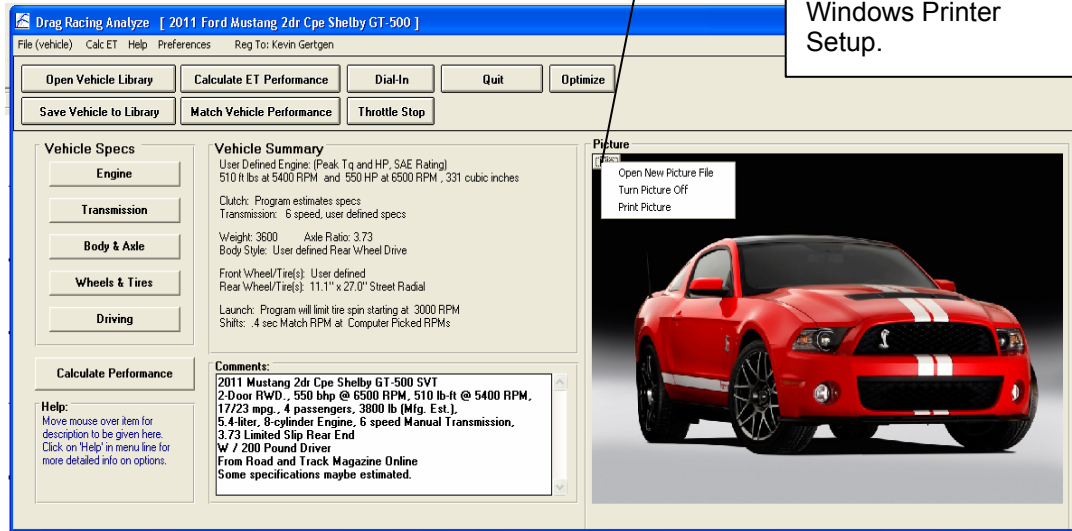

Figure A9 Including the Graphics File on Printouts

Calculate Performance to obtain results. Then click on Print.

Gear	RPM	EngRPM	Tq Mult	C Slip	T Slip	% Thrt
1	3000	1.00	100	5	43	
RO	00	6714	1.00	91	5	43
1	283	7200	1.00	27	5	44
1	145	7150	1.00	0	5	39
2	259	7337	1.00	42	5	66
2	227	6255	1.00	16	5	68
2	582	6682	1.00	0	4	100
2	970	6970	1.00	0	3	100
3	048	7271	1.00	31	5	99
3	132	6132	1.00	0	2	100
3	141	6141	1.00	0	2	100
3	890	6890	1.00	0	1	100
4	258	7246	1.00	27	2	100
4	365	5365	1.00	0	1	100
4	887	5887	1.00	0	0	100

Click here to make printout. If you have a picture file for printing, it is always printed. You have to turn off the picture at the main screen to have it not printed.

Drag Racing Analyzer v3.4
 Eng: 2011 Ford Mustang 2dr Cpe Shelby GT-500
 Calculated Test Results

Registered to:
 Kevin Gertgen
 Performance Trends (C) 2009

This Report Printed:
 4:41:35 pm 05-12-11
 Page: 1

Example of printout with graphics file.

Projected Performance										
Gear	Time	MPH	Accel Gs	Feet	C RPM	EngRPM	Tq Mult	C Slip	T Slip	% Thrt
1	-.259	.00	.73	-1	0	3000	1.00	100	5	43
RO	.000	4.13	.73	0	600	6714	1.00	91	5	43
1	2.012	36.34	.74	60	5283	7200	1.00	27	5	44
1	2.820	49.15	.65	111	7145	7150	1.00	0	5	39
2	3.220	48.90	.65	140	4259	7337	1.00	42	5	66
2	3.993	60.00	.66	202	5227	6255	1.00	16	5	68
2	5.258	77.56	.56	330	6682	6682	1.00	0	4	100
2	5.631	81.88	.49	374	6970	6970	1.00	0	3	100
3	6.031	81.39	.68	422	5048	7271	1.00	31	5	99
3	7.813	99.83	.42	660	6132	6132	1.00	0	2	100
3	7.831	100.00	.42	663	6141	6141	1.00	0	2	100
3	9.390	113.07	.33	907	6890	6890	1.00	0	1	100
4	9.790	112.25	.47	973	5258	7246	1.00	27	2	100
4	9.951	113.73	.33	1000	5365	5365	1.00	0	1	100
4	11.766	126.02	.29	1320	5887	5887	1.00	0	0	100

Current:	ET	11.766	MPH	124.87
Last:		11.766		124.87
Improvement:		.000		.00

Figure A10 Instant Calc results on Main Screen

Preference for new tire calculation method.

Turning on Instant Calculations in Preferences.

Instant Results shown here on main screen after each vehicle modification.

Current Performance: [11.766 @ 124.87 2.012 60 ft]

Comments:
 2011 Mustang 2dr Cpe Shelby GT-500 SVT
 2-Door RWD, 550 bhp @ 6500 RPM, 510 lb-ft @ 5400 RPM,
 17/23 mpg., 4 passengers, 3800 lb (Mfg. Est.),
 5.4-liter, 8-cylinder Engine, 6 speed Manual Transmission,
 3.73 Limited Slip Rear End
 W / 200 Pound Driver
 From Road and Track Magazine Online
 Some specifications maybe estimated.

Figure A11 More Example Vehicle Files

Open a Vehicle File

100 Ex. Vehicles in Library

- 2011 Chevrolet Camaro LT Convertible Coupe
- 2011 Chevrolet Camaro LT Coupe
- 2011 Chevrolet Camaro SS Convertible Coupe
- 2011 Chevrolet Camaro SS Coupe
- 2011 Chevrolet Corvette Coupe
- 2011 Chevrolet Corvette ZR1 3ZR
- 2011 Chevy Corvette Z06 Coupe
- 2011 Dodge Challenger 2dr. Coupe
- 2011 Dodge Challenger 2dr. Coupe SRT8**
- 2011 Dodge Charger RT Stock
- 2011 Dodge Charger SRT8 Stock
- 2011 Dodge Charger Stock
- 2011 Ford Mustang 2dr Cpe
- 2011 Ford Mustang 2dr Cpe GT

Chosen Ex. Vehicle File: 2011 Dodge

Preview:

CID: 392	Wt: 4375
470 HP @ 6000	Axle Ratio: 3.92
Pk Tq & HP	Rear Whl Drv
6 Speed	Frnt Area: 24.98
Manl Trans	Drag Coef: .36

2011 Dodge Challenger 2 Dr. Coupe SRT8
 6.4L V-8 Engine, 6 Speed Manual
 Transmission,
 W / 200 Pound Driver
 Courtesy of Road and Track Online
 Picture Courtesy of SupercarsHD.com

List Alphabetically (typical listing)
 List by Date Last Changed

Open Delete Cancel Help

Show Only Files which contain this phrase Show All Files

Appendix 5: New Features in Version 3.4 B

Here is a brief listing of some of the features new in Version 3.4 B:

- Program has several new Example vehicle files, including an all electric Tesla, most with picture files. Fig A12.
- Program now allows for 4 more transmission ratios so you can specify up to 10 speed transmissions, either manual or automatic in Transmission Specs. Fig A13.
- You can now specify an automatic torque converter to lock up at some particular gear ratio. At that gear ratio and all higher gears, the converter is assumed to remain locked. Fig A13.
- Program now also has 4 more gear shift RPMs in Driving Specs screen. Fig A14
- Added a setting for number of gears in the transmission, and program now hides gear ratios not needed. This makes it more clear how the program is using transmission gears. Prior to v3.4B, the program just looked for a blank or zero input for a ratio to know that gear was not being used. Fig A13
- Now, if the program finds that converter is too loose for a combination User Selected shift RPMs and the particular power curve, the program now switches to Computer Picked Shift RPMs so the calculations can continue.
- The program now has greatly enhanced graphing options, similar to our larger programs. You can overlay more runs, zoom in, specify grid layout, have more printout and labeling options, and much more. Figs A15 through A27.
- Now when you delete a file, it now goes to the Recycle Bin so you can 'recover it later if you need to. Fig A29 and Fig A30.
- The program now has an "Advanced" button for saving or opening data files or external drives or other folders on your computer. Fig A28
- The program now better checks for some values for producing errors and fixes the problems so the calculations can continue, without producing error messages.
- Program now has a "Compress Picture File" as a File option for pictures, which explains how to compress picture files with 3rd party program.
- Program now better handles direct drive transmission and 1 gear transmissions.
- You can now retrieve files from History Log.
- Program now better deals with external drives for saving and opening files, and no longer calls them "Floppy Disks".
- Program now saves more of the graph settings for printing and comments.

Figure A12 New Vehicle Files

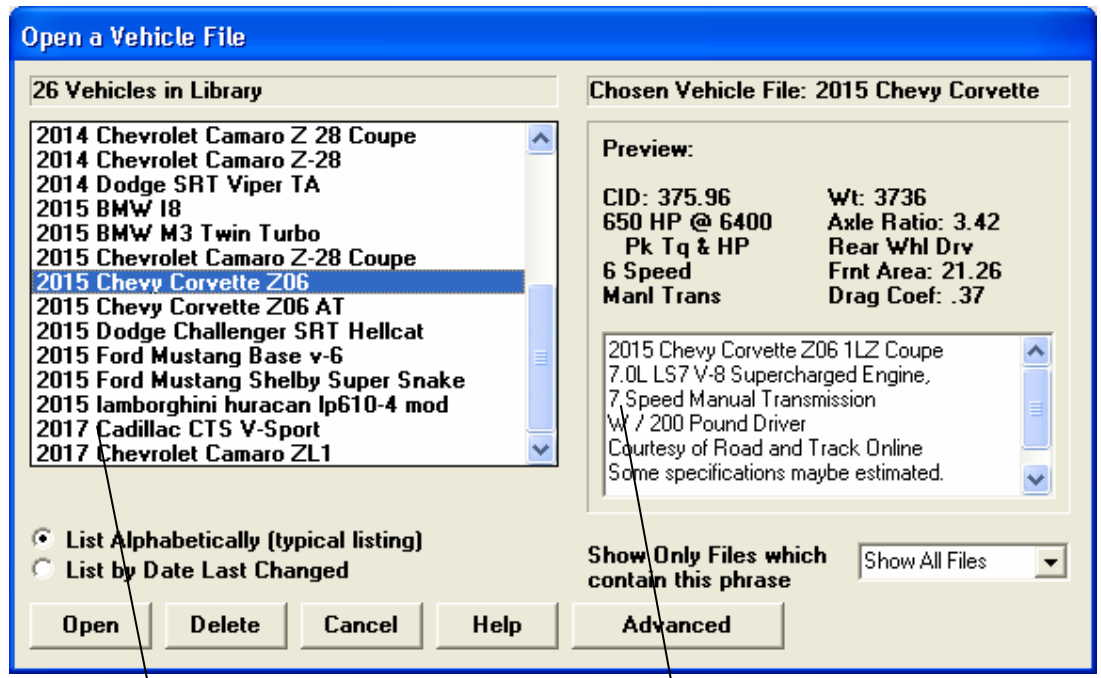

Newer vehicles can now accommodate up to 10 speed transmissions.

Many new later model vehicles have been added.

Figure A13 New Transmission Specs

Transmission Specs [11.095 @ 123.10 1.558 60 ft]

Clutch/Converter		Transmission	
Type	Let program Estimate Clutch Specs	Type	Use Specs Below
Clutch Diameter, in	10	Efficiency, %	93 Good 90s 3 & 4 spd Auto
Clutch Force, lbs	3333	Number of Trans. Gears	10
# Clutch Disks	1	First Gear Ratio	4.7
Clutch Material	Organic ('rag')	Second Gear Ratio	2.99
		Third Gear Ratio	2.15
		Fourth Gear Ratio	1.77
		Fifth Gear Ratio	1.52
		Sixth Gear Ratio	1.28
		Seventh Gear Ratio	1
		Eighth Gear Ratio	.85
		Ninth Gear Ratio	.69
		Tenth Gear Ratio	.64

OK Print Get Example
Help Print Setup Save Example

Help

Your choice here will determine how many gear ratio inputs are displayed. In this case it is 10.

Transmission Specs [10.609 @ 125.74 1.444 60 ft]

Clutch/Converter		Transmission	
Type	Torque Converter, Use Specs Below	Type	Use Specs Below
Converter Capacity	179.7	Efficiency, %	93 Good 90s 3 & 4 spd Auto
Conv Tq Multiplication	1.8	Number of Trans. Gears	10
Converter Stall RPM based on Current Converter Capacity	4380	First Gear Ratio	4.7
		Second Gear Ratio	2.99
		Third Gear Ratio	2.15
		Fourth Gear Ratio	1.77
		Fifth Gear Ratio	1.52
		Sixth Gear Ratio	1.28
		Seventh Gear Ratio	1
		Eighth Gear Ratio	.85
		Ninth Gear Ratio	.69
		Tenth Gear Ratio	.64
		Converter Locks Up	6th Gear

OK Print Get Example
Help Print Setup Save Example

Help

If you specify an automatic transmission, by picking a Torque Converter Type....

You have the option of picking a gear at which the converter locks up (no slip). All gears above this are also locked up.

Figure A14 New Driving Specs

Driving Specs [11.095 @ 123.10 1.558 60 ft]

Launch Specs		Shift Specs	
Type	Clutch-Hold Launch RPM-No tire spin	Shift Time, sec	.4 Typical
Launch RPM	3000	Shift % Throttle	50 Match RPM
Launch % Clutch	60	Shift RPMs	Use RPMs below
Launch % Throttle	60	1-2 Shift RPM	6400 Clc
Launch Time, sec	1	2-3 Shift RPM	6400 Clc
		3-4 Shift RPM	6400 Clc
		4-5 Shift RPM	6400 Clc
		5-6 Shift RPM	6400 Clc
		6-7 Shift RPM	6400 Clc
		7-8 Shift RPM	6025 Clc
		8-9 Shift RPM	4600 Clc
		9-10 Shift RPM	4150 Clc

Help
Click on arrow button to pick type of launch from list.
p 38

OK Help Print Printer Setup

Because there are now up to 10 transmission ratios, there are now Shift RPMs available for all 10 gears.

Graphs are obtained by clicking on the Graph button or the Graph name in the menu bar at the top of the tabular results screen shown in Figure 3.2, Chapter 3. Figure A15 below shows a typical graph and descriptions of some of the basic graph screen items.

Figure A15 Basic Graph Screen Items

- Command buttons perform action as pictured with 1 click of mouse.
- Menu bar provides for several graph commands and options. Commands to the right of the “|” provide a short cut to commonly used commands.
- Graph Title: change by clicking on Format, then Edit Titles/Legend.
- ‘Short cut’ commands appear to the right of this bar.
- Name of current Engine File

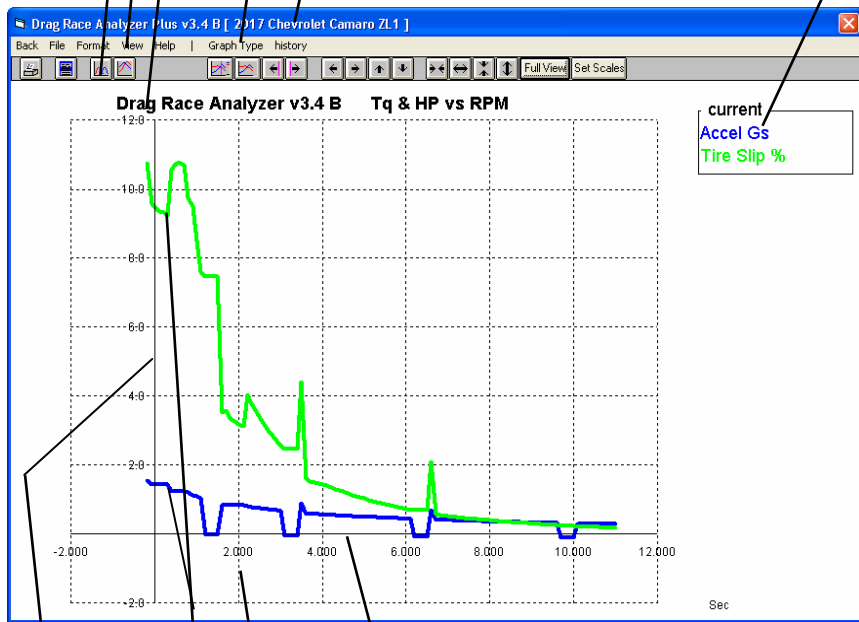

Graph Legend, which describes the data graphed. This includes Name of test results, Type of Data. Names in the Legend can be changed by clicking on Format, then Edit Titles/ Legend.

- Horizontal X axis. The scaling of this axis can be easily changed as described in this section.
- Grid lines. The style or elimination of grid lines can be changed by clicking on Format, then Grid Style.
- Data graph lines. The style and thickness of these lines can be changed by clicking on Format, then Line Style.
- Vertical Y axis, the scaling of which can be changed as described in this section.

There are several types of data which can be graphed, including:

- Engine RPM
- MPH, vehicle speed in miles per hour.
- Clutch or torque converter RPM.
- Feet is the distance down the track.
- Accel Gs is acceleration rate in Gs.
- Engine HP is the amount of HP being delivered to the clutch converter. This is affected by Driving Specs, engine RPM, weather conditions, and the shape of the power curve.
- Throttle, % is the amount the throttle is opened, where 100% mean wide open throttle or full power. Throttle is affected by Driving Specs and can be limited to prevent tire spin.
- Clutch or Converter RPM is the input to the transmission.
- Tire Slip, % is the amount the tires are slipping. Even though tires have not broken loose, they can still be slipping up to 10-15%.
- Clutch or Converter Slip, % is the difference between Clutch or Torque Converter RPM and Engine RPM, expressed as a percent. If the clutch or converter are locked, this will be 0%.

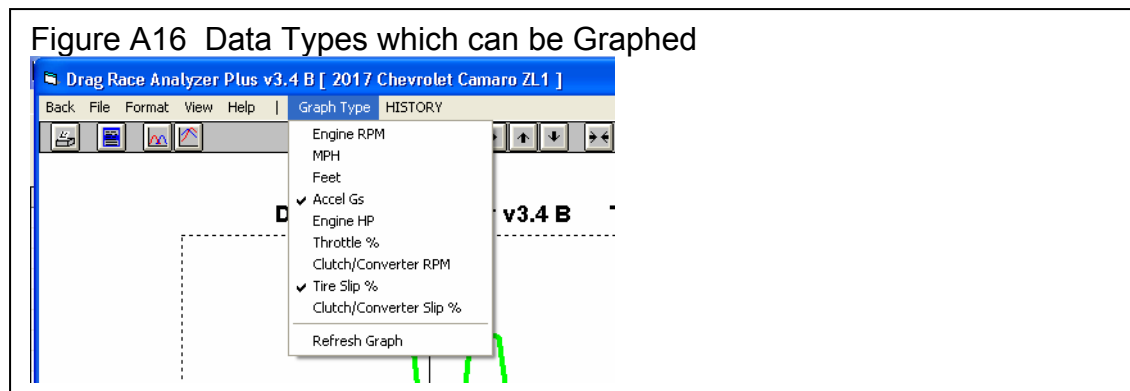

There are basically 2 types of graphs you can produce:

- **Current test results.** These are the test results for the data displayed in the Test Results screen, for the current Vehicle specs and conditions, the last run you made.
- **Test results from the History Log.** The History Log is a list of 25 tests, some of which you have specified you want saved long term, some of which are simply the last tests you have run.

The History Log is explained in some detail in Section 3.5 starting on page 105. This section will explain how to graph test results for tests in the History Log.

Figure A17 History Log for Graphing

Click on the History menu item to display the History Log shown below.

Click Graph Options, then Graph Single Test to just graph the Current Test Results.

The screenshot shows the 'Drag Race Analyzer Plus v3.4 B' interface. The main window displays a graph titled 'Tq & HP vs RPM' with a y-axis ranging from 6400 to 9600. A legend on the right lists several tests: '2017 chevrolet camaro zl1: thu oct 5 Engine RPM', '1968 plymouth barracuda superstock AH: Engine RPM', '1962 ac ford shelby stock: thu oct 5 Engine RPM', and '1968 ford mustang 390 ci stock: thu oct 5 Engine RPM'. Below the graph is a 'Test History' window with a table of test results.

Test Title	Graph?	Graph Title	Keep	Fast	Drag	Alt	(Dry Drag)	EO R	Imprvmt(ET)	Imprvmt(MPH)	Imprvmt	
2017 Chevrolet Camaro ZL1: Thu Oct 5 17		2017 Chevrolet Camaro		1320	2961	3049	1.558	-.40	11.095	-2.81	123.10	-39.56
1968 Plymouth Barracuda Superstock AH: Thu Oct 5 17	Yes	1968 Plymouth	Yes	1320	1431	1686	1.152	.00	8.295	.00	162.65	55.31
1962 AC Ford Shelby Stock: Thu Oct 5 17	Yes	1962 AC Ford Shelby	Yes	1320	1693	1941	2.050	.41	13.714	1.50	107.35	9.03
1968 Ford Mustang 390 CI Stock: Thu Oct 5 17	Yes	1968 Ford Mustang 390		1320	1693	1941	2.453	-.91	14.992	-3.60	98.32	-24.79
2017 Chevrolet Camaro ZL1: Thu Oct 5 17		2017 Chevrolet Camaro		1320	2961	3049	1.558	-.40	11.095	-2.81	123.10	-39.56
1968 Plymouth Barracuda Superstock AH: Thu Oct 5 17		1968 Plymouth		1320	1431	1686	1.152	.00	8.295	.00	162.65	.00
1968 Plymouth Barracuda Superstock AH: Thu Oct 5 17		1968 Plymouth		1320	1431	1686	1.152	.00	8.295	.00	162.65	.00
1968 Plymouth Barracuda Superstock AH: Thu Oct 5 17		1968 Plymouth		1320	1431	1686	1.152	.00	8.295	.00	162.65	.00
1968 Plymouth Barracuda Superstock AH: Thu Oct 5 17		1968 Plymouth		1320	1431	1686	1.152	.00	8.295	.00	162.65	.00
1968 Plymouth Barracuda Superstock AH: Thu Oct 5 17		1968 Plymouth		1320	1431	1686	1.152	.00	8.295	.00	162.65	.00

Click in the 'Graph?' column to insert a 'Yes' or remove an existing 'Yes' to identify which tests you want graphed.

Click in this column to show Yes or remove Yes. Tests marked Yes will be graphed.

Click on 'Graph These Tests' to close the History Log and graph the tests identified by the menu option you pick.

This column shows name program will display in graph Legend for this test. Click on name to change it.

Click and drag slide bar to display entire History Log. Some tests marked Yes may be at the bottom of the Log and not be visible now.

Other Graphing Features

The graph screen has several features, including:

- Printing
- Cursor to pinpoint the value of a particular point on the graph
- Changing titles and legend names
- Changing the scales
- Miscellaneous Format Options to change the appearance of the graph.

These are discussed in this next section.

Printing

Figure A18 shows the options for printing graphs and how to access these options. It also shows the screen for changing the Windows Printer Setup.

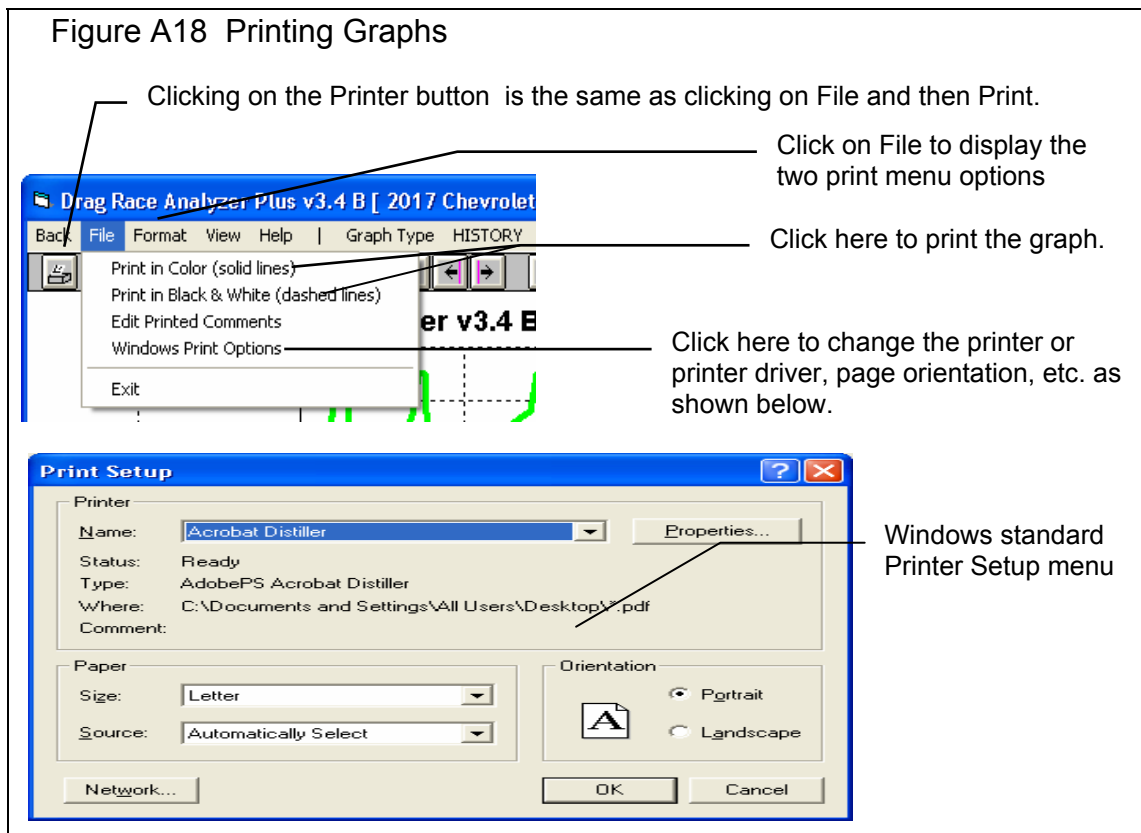

Cursor

The cursor feature is very useful for determining or comparing the value of the graph lines at various places. See Figure A19 for explaining the use of the cursor.

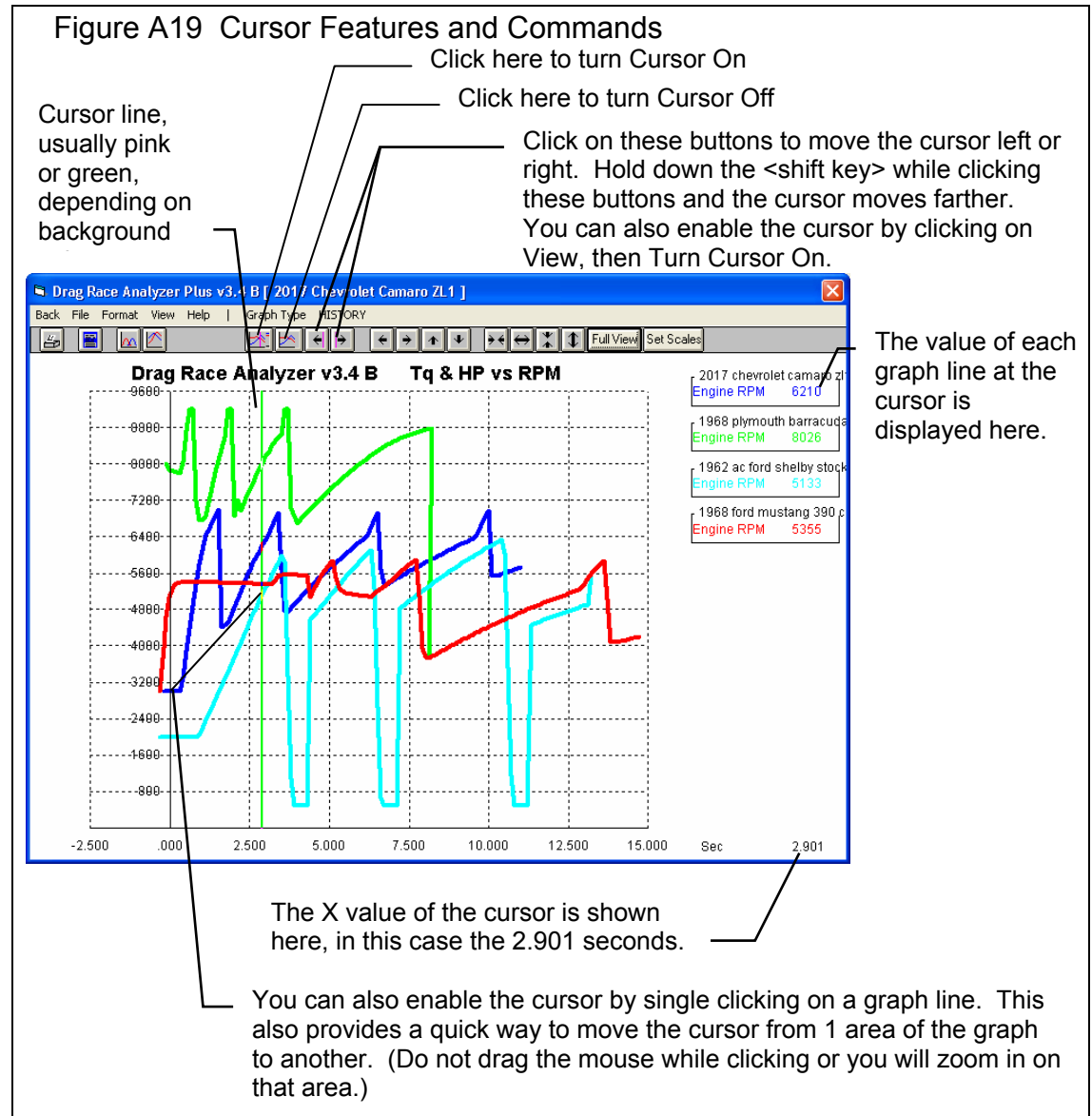

Changing titles and legend names

Many times you may want to customize a graph by printing labels of your choice. Click on Format and then Edit Titles/Legend to bring up the menu shown in Figure A20 which will allow you to do this.

Figure A20 Menu to Edit Title and Legend

This is the list of Standard names the program uses unless you click on the Use New Titles button below. Select (click on) a Standard name you want to change. The Standard Name appears in the edit box, along with the current New name if there is one. **Once you have selected a name from this list (that row will be highlighted) it is easier to use the up and down arrow keys to select the next item to edit than clicking the item with the mouse.**

This is the list of New names the program will use if you click on Use New Titles. If a title in the List of New Names is blank, the program will use the Standard name.

Standard name from row selected.

New name for you to edit. Other options include clicking on the Copy Std Name to New or Blank Out New Name buttons.

Click here to close this menu and use the New names you have entered. Where New names have been left blank, the Standard name will be used.

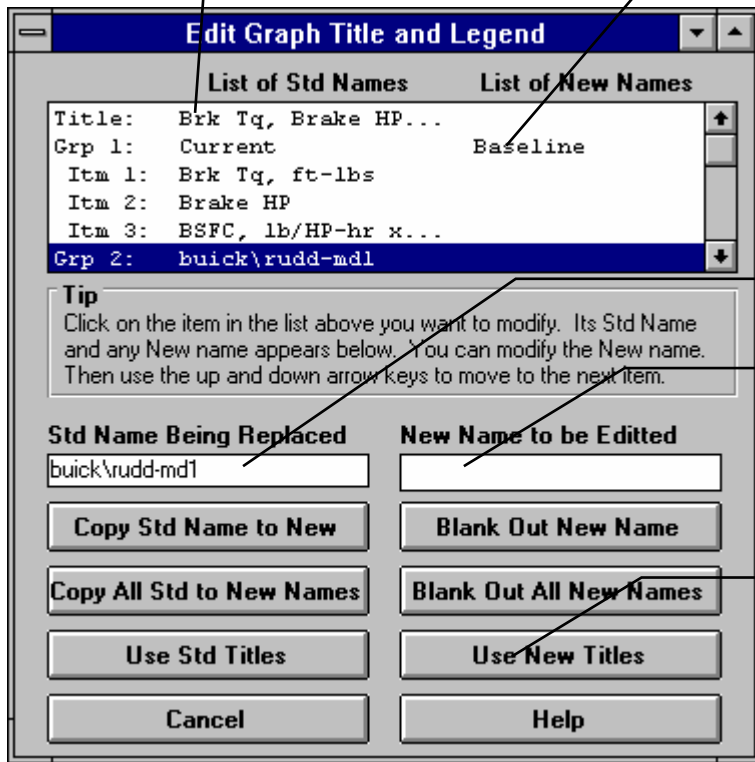

Changing the scales

Many times you may want to change the scale of the X or Y axis. This may be to show an area in more detail or to match the scales of a previous graph. The Drag Racing Analyzer has several ways to change the scales as shown in Figures A21 and A22.

Figure A21 Changing Scales for the X or Y Axis

Clicking on these buttons zooms in or zooms out on the graph, either vertically or horizontally. Hold down the shift key to produce faster action.

Clicking on these buttons shifts the graph left, right, up or down. Hold down the shift key while clicking produces faster action.

Click here to restore "auto-scaling". That is where the computer picks the scale to show all the graph in good detail.

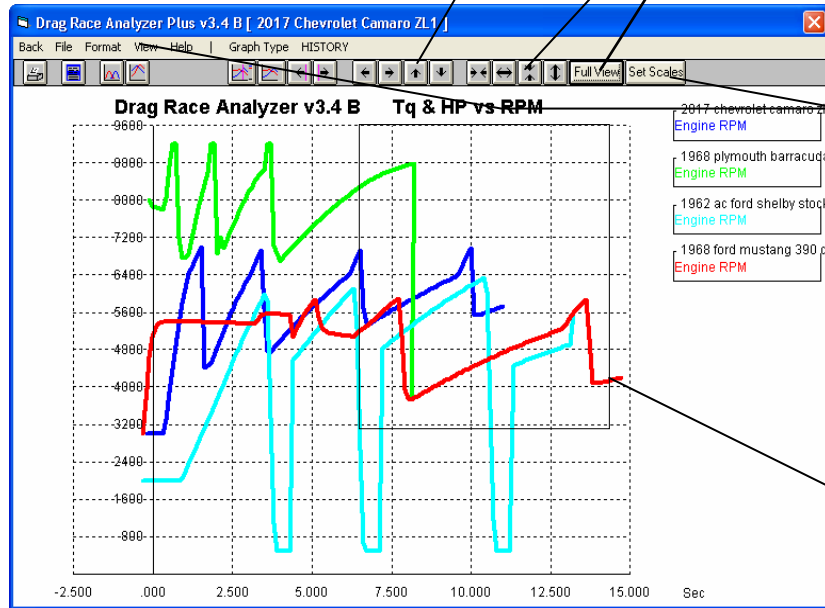

Click on View, then either Zoom or Specify Scales (axes), or the Set Scales button to obtain the menu shown in Figure A22 on the next page.

You can use the mouse to outline an area to be zoomed in on. Simply click on the mouse key in the upper left corner of the area, then hold the key down and drag the mouse to the lower right corner of the desired area. A box will be drawn as shown. When you release the mouse key, this area will fill the whole graph. This feature is disabled if the cursor is turned on. Also, start the upper left corner well away from a graph line or the program may turn on the cursor instead.

Figure A22 Menu to Specify Graph Axes Scales

This menu can be obtained 2 ways. You can click on View in the menu bar then Specify Scales (axes), or click on the Set Scales button, the right most button on the screen. See Figure A21.

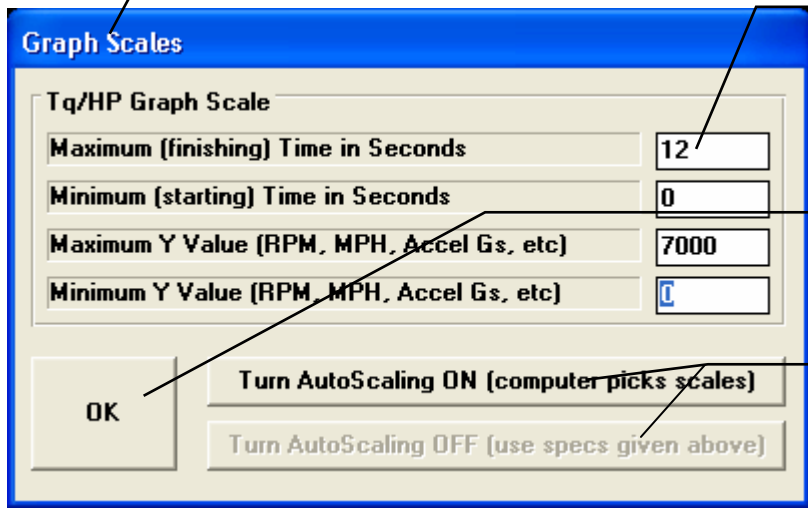

The current scale limits are loaded when this menu opens. Change any or all these to most any value you want.

Click on OK to have the graph redrawn to these new scale limits .

These buttons determine if these scales are used, or graph is "auto-scaled".

Format Options

Click on the Format menu item to be presented with several options which will be briefly discussed here.

Line Style

Click on Line Style to change the thickness of the graph lines.

Titles and Labels

Click on Titles and Labels to bring up option screen shown in Figure A18. See choices shown in Figure A22.

Figure A23 Format Options

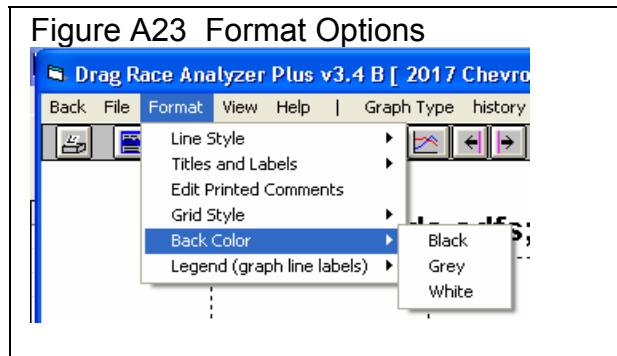

Edit Printed Comments

Click on Edit Printed Comments for the screen shown in Figure A23. These settings only affect printouts.

Grid Style

Click on Grid Style to change or omit the drawing of grid lines on the graph.

Back Color

Click on Back Color to change the background color of the graph from white, black or gray. Different Back Colors can make certain line colors stand out better, so experiment with your particular computer display and Line Style (thickness).

Figure A24 Titles and Labels

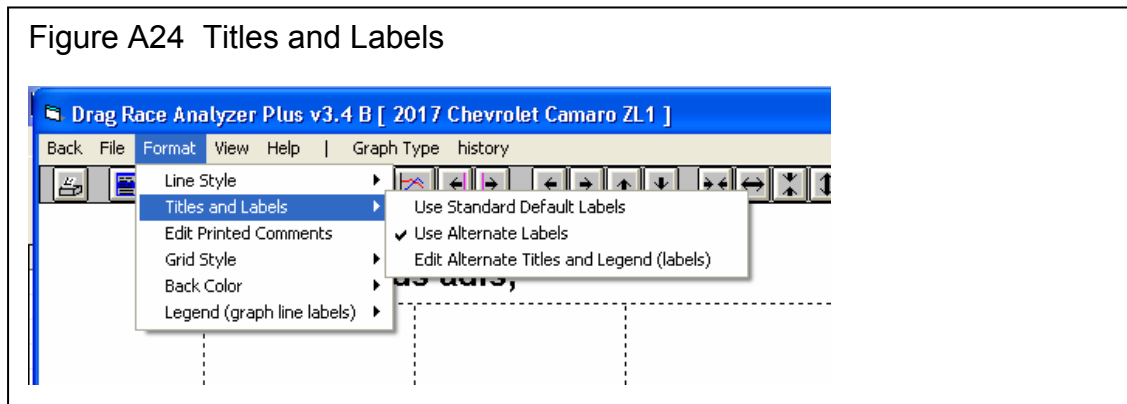

Figure A25 Edit Printed Comments

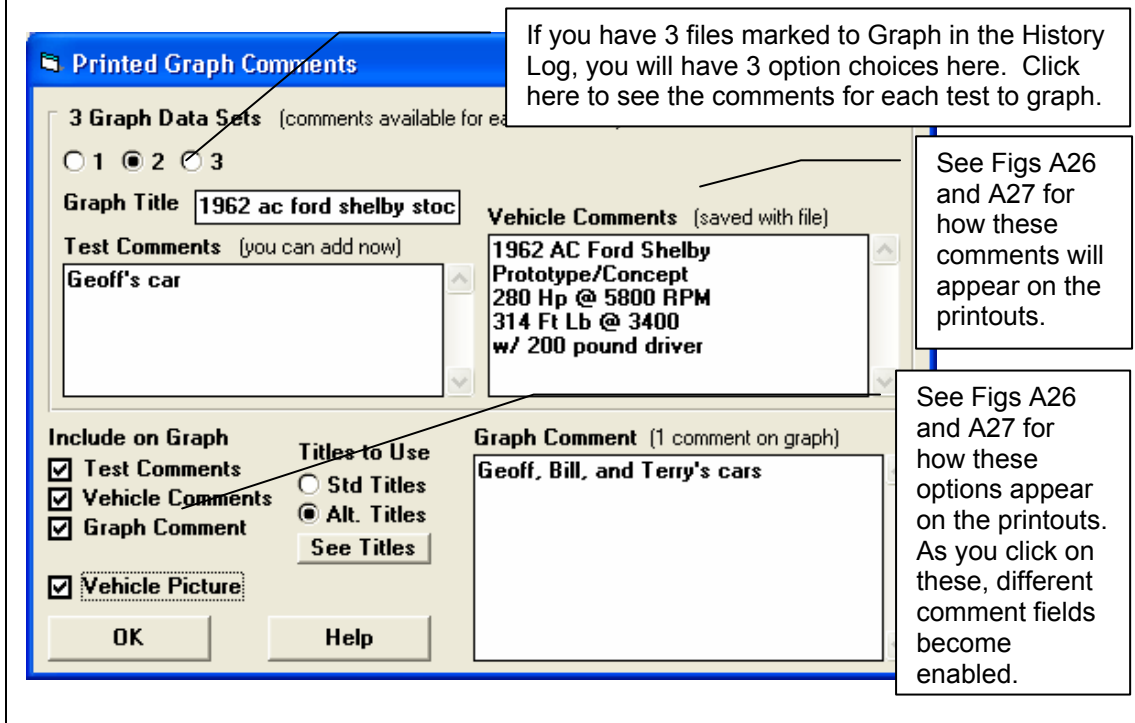

Figure A26 Graph Printout with Printing Options

Drag Racing Analyzer v3.4 B
Eng: 2017 Chevrolet Camaro ZL1
Calculated Test Results

Registered to:
Kevin Gertgen
Performance Trends (C) 2017

This Graph Printed:
5:43 am 10-06-17
Page: 1



Checking Vehicle Picture option puts picture file here.

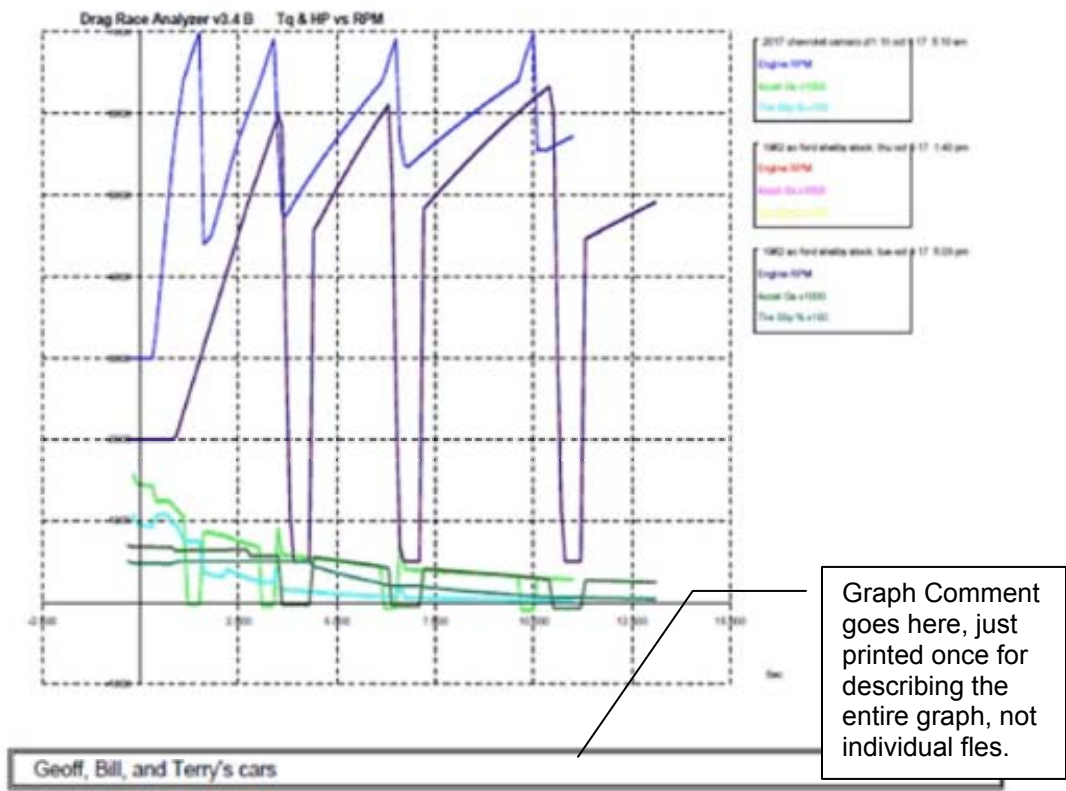

Figure A27 Graph Printout with Printing Options, cont

Drag Racing Analyzer v3.4 B Eng: 2017 Chevrolet Camaro ZL1 Calculated Test Results	Registered to: Kevin Gertgen Performance Trends (C) 2017	This Graph Printed: 8:51 am 10-06-17 Page: 2
Test and Engine Comments for: 2017 Chevrolet Camaro ZL1: Fri Oct 6 17 5:10 am Terry's car		
2017 Chevrolet Camaro ZL1 Supercharged and intercooled pushrod 16-valve V-8, aluminum block and heads, direct fuel injection. 376 cu in, 6162 cc, 650 hp @ 6400 rpm, 650 lb-ft @ 3600 rpm Some specifications maybe estimated. Car & Driver track sheet 12/16/16 1/4 Mile 11.5 sec. @ 125 Mph		
Test and Engine Comments for: 1962 AC Ford Shelby Stock: Thu Oct 5 17 1:40 pm Geoff's car		
1962 AC Ford Shelby Prototype/Concept 280 Hp @ 5800 RPM		314 Ft Lb @ 3400 w/ 200 pound driver
Test and Engine Comments for: 1962 AC Ford Shelby Stock: Tue Oct 3 17 5:03 pm Bill's car		
1962 AC Ford Shelby Prototype/Concept 280 Hp @ 5800 RPM		314 Ft Lb @ 3400 w/ 200 pound driver

Test Comment. These are entered in screen of Fig A25 and can be anything you want.

Test File Name, with run time and date.

File Comments for the 2nd test marked Yes to Graph in the History Log.

Test File Name and Test Comment for 2nd test marked Yes to Graph in the History Log.

File Comments, which are the comments you enter on the main screen, and are saved with each vehicle file.

Figure A28 New Advanced Button For Opening and Saving Files

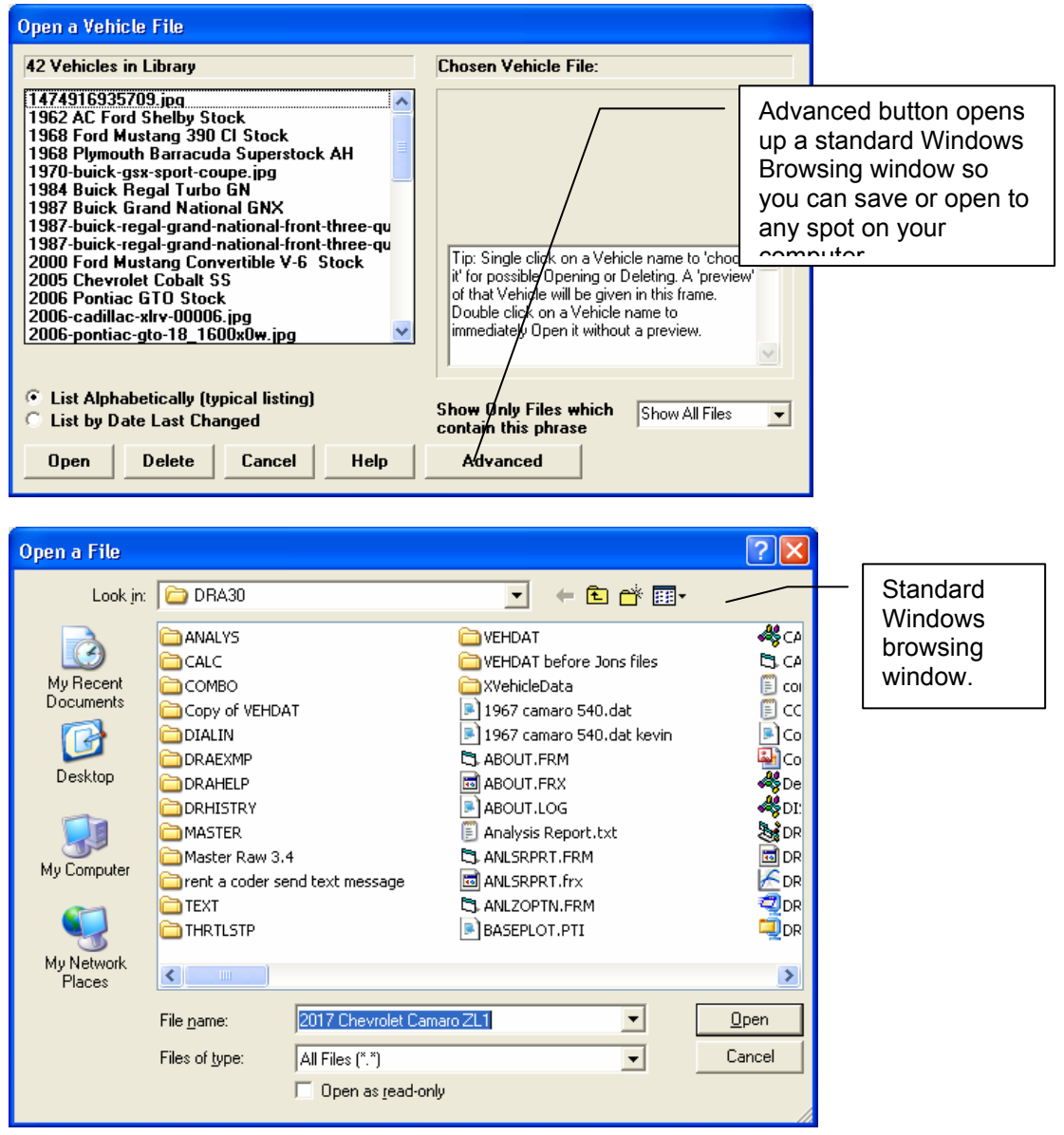
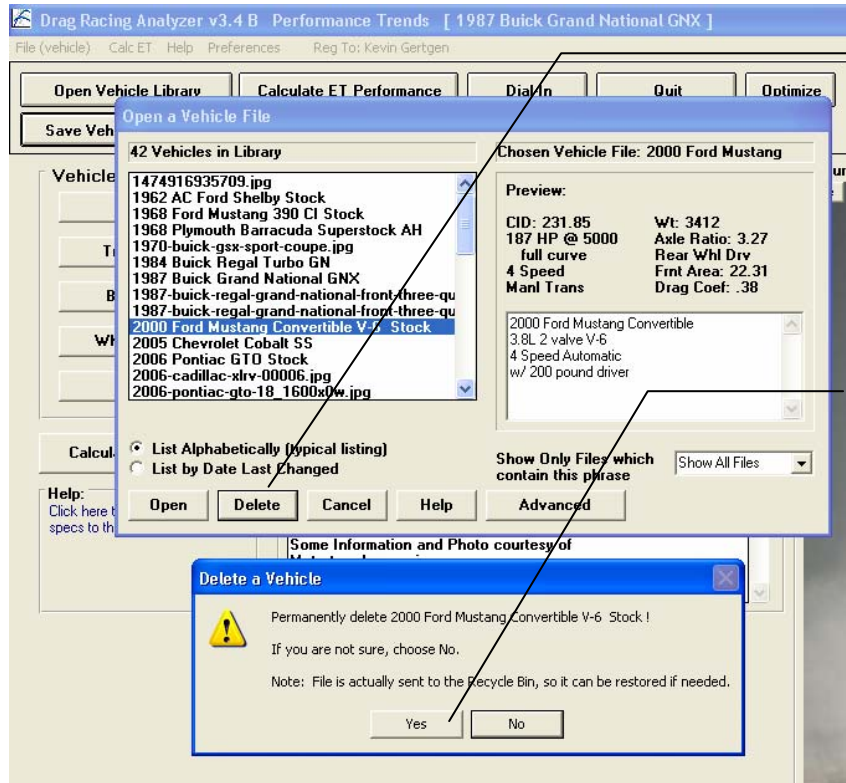
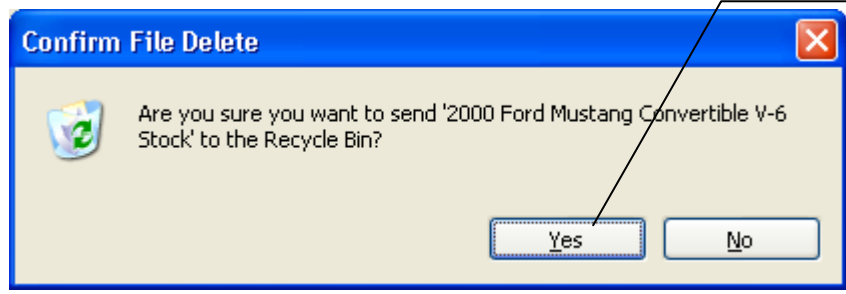

Figure A29 Deleted Files now go to Recycle Bin



Click on a file name to highlight it, then click the Delete button to delete it.

Program asks you to confirm deleting, and says it will go to the Recycle Bin.



Program again confirms it is going to the Recycle Bin.

Figure A30 Retrieving Deleted Files from Recycle Bin

If you need to bring back (restore) a file you have deleted by mistake, open the Recycle Bin icon on your desktop.

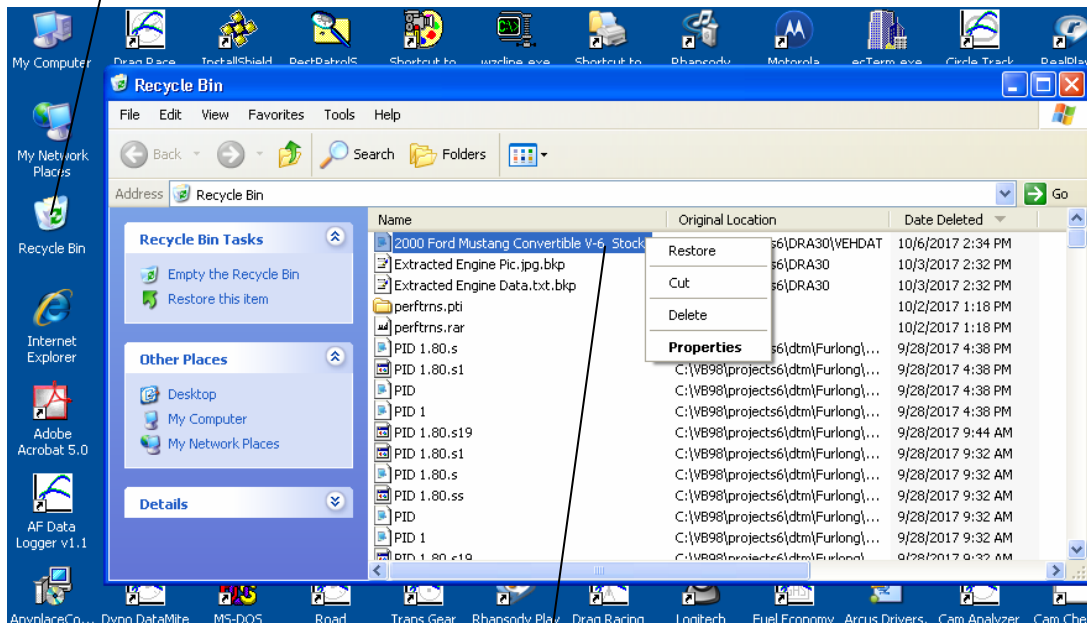

Find the file to restore, right click on it and select Restore and it will be restored to your list of vehicle files so you can again open it inside the Drag Racing Analyzer.

Index

- 4 wheel drive, 28
- 60 foot time, 7, 13, 75, 77, 80, 81, 82, 85, 106, 129, 134, 136, 140, 141, 142
- 60 foot, sec, 80, 81, 85
- Accel Gs, 1, 58, 97, 144, 174
- Acceleration, 1, 29, 36, 37, 57, 58, 63, 143, 144, 146, 149, 151, 174
- Advanced Saving/Opening Files, 169
- Aerodynamics, 32, 33, 120, 147, 148
- Air Temperature**, 51, 79, 84, 120, 123
- All Wheel Drive, 24, 28
- Altimeter, 1, 50, 51, 52, 80, 84, 140
- Analysis Report, 5, 1, 91, 93, 94
- Aspect Ratio, 69
- Assumptions, 6, 3, 18, 28, 30, 31, 35, 41, 52, 58, 62, 136, 142, 145, 146
- Axle Ratio, 6, 108, 114, 117
- Back Color, Graph, 181
- Background Color, 98
- Barometer, 1, 50, 51, 52, 79, 84, 106, 120, 123, 134, 140
- Baseline, 1, 8, 95, 96, 98, 108, 116, 151
- Baselinexe "Baseline" is a Selected Run, 98
- Beginner, 13, 39
- Body & Axle, 5, 11, 26, 34, 35, 63, 65, 66, 67, 88, 113, 120, 122, 125, 126
- Bog (Engine), 39, 116
- Bonneville, 53, 54, 106
- C RPM, 58
- C Slip, 58
- Calculate Performance, 5, 6, 9, 49, 55, 71, 72, 77, 82, 98, 108, 109, 111, 114, 119, 120, 121, 122, 123
- Calculate Performance Conditions, 5, 6, 8, 9, 49, 71, 72, 109, 119, 120, 121, 122, 123
- Calculation Menu, 5, 9, 17, 18, 60, 61, 71, 72, 119, 121, 122, 125, 154
- Calculation Menus, 5, 9, 17, 18, 60, 61, 71, 72, 119, 121, 122, 125
- CG, 29
- Chain, 27, 65, 66
- Circumference, 36, 68, 69
- Clc button, 9, 16, 17, 18, 27, 29, 31, 36, 37, 42, 51, 60, 61, 62, 65, 70, 71, 72, 77, 81, 82, 86, 121, 123, 125, 137, 141
- Clc Button, 9, 16, 17, 18, 27, 29, 31, 36, 37, 42, 51, 60, 61, 62, 65, 70, 71, 72, 77, 81, 82, 86, 121, 123, 125, 137, 141
- Clutch Diameter, 22
- Clutch Force, 22, 148
- Clutch Material, 23
- Clutch or Converter and Engine RPM, 97, 115
- Clutch/Converter, 22, 24, 124
- Comments, 5, 8, 79, 84, 104, 130, 140, 169
- Compress Picture File, 169
- Computer Driven (Launch), 39, 42, 45, 46, 111, 127, 147
- Construction (Tire), 36, 37, 74, 117, 120
- Conv Tq Multiplication, 24, 58, 116, 118, 124, 148, 153
- Converter, 1, 2, 16, 21, 22, 23, 24, 40, 41, 45, 46, 47, 58, 59, 74, 75, 97, 111, 112, 120, 122, 124, 143, 145, 146, 147, 148, 149, 150, 152, 153, 154, 169, 174
- Converter Capacity, 2, 23, 40, 45, 46, 74, 124, 147, 148, 149, 152, 153
- Converter lock up, 27, 169
- Corr. Factor, 17
- Current Run, 56, 96
- Cursor, Graph, 176, 177
- Data to Graph, 97
- Density Altitude, 1, 106
- Dew Point, 1, 9, 17, 18, 51, 71, 72, 73, 79, 84, 120, 121, 123, 144
- Dial In, 5, 6, 1, 13, 71, 72, 82, 83, 84, 86, 132, 133, 134, 135, 136, 137, 138, 141, 155, 158
- Diff Lock Eff, 27, 125
- Differential, 27, 65

Disabled, 16, 22, 28, 30, 31, 36, 37, 39, 40, 41, 50, 51, 61, 121, 123, 124, 127, 140
 Displacement, 16, 63, 120, 121, 152
 Distance, 1, 29, 30, 35, 36, 37, 54, 56, 57, 58, 67, 69, 75, 106, 109, 150, 174
 Distance of Race, 75
 Dnsy Alt, 1, 106
 Drag Coefficient, 32, 33, 120, 147, 148
 Drag Racing Analyzer Pro, 1
 Drag Slicks, 36, 37, 117, 120, 126
 Drag Strip, 3, 7, 53, 56, 57, 111, 113, 132, 134, 138, 147, 155
 Driveline Layout, 28, 34, 35
 Driving Specs, 5, 38, 41, 42, 70, 111, 117, 120, 127, 128, 147, 148, 149, 169, 174
 Dry Bulb, 1, 9, 51, 71, 72, 73, 120, 123
 Dry Density Altitude, 1, 52, 106
 Dry Dnsy Alt, 1, 106
 Dynamometer, 18
 Dynamometers, 16, 17, 62, 121, 147, 149

 Edit Printed Comments, Graph, 181
 Efficiency, 24, 28, 36, 147, 148
 Eighth Mile MPH, 62, 63, 121
 El Mirage, 53, 54, 106
 Engine, 4, 5, 1, 6, 14, 15, 16, 17, 18, 19, 20, 22, 23, 24, 27, 29, 32, 38, 39, 40, 41, 42, 43, 44, 45, 46, 47, 50, 57, 58, 59, 60, 61, 62, 63, 64, 65, 66, 74, 76, 90, 94, 97, 100, 103, 109, 111, 112, 113, 116, 119, 120, 121, 122, 124, 129, 136, 142, 143, 145, 147, 148, 149, 150, 151, 152, 154, 155, 164, 174
 Engine Analyzer, 1, 16, 17, 18, 19, 20, 155, 164
 Engine Cubic Inches, 60, 61, 63
 Engine Graph, 14
 Engine RPM, 1, 23, 39, 40, 42, 43, 45, 46, 47, 57, 58, 97, 111, 112, 116, 129, 148, 149, 151, 174
 EngRPM, 58
 Estimate Change in 60 Foot Time, 80, 81, 85, 136, 141
 ET Timer, 54, 57
 ET, sec, 80, 85
 Example, 5, 6, 1, 5, 9, 13, 16, 17, 18, 19, 22, 23, 24, 25, 27, 28, 29, 31, 32, 34, 35, 37, 39, 40, 41, 42, 43, 44, 47, 50, 51, 52, 57, 60, 61, 67, 71, 74, 75, 77, 86, 87, 88, 89, 90, 93, 100, 105, 107, 108, 113, 118, 119, 120, 121, 122, 124, 125, 126, 131, 132, 134, 135, 136, 138, 140, 144, 145, 146, 147, 149, 150, 151, 152, 154, 155, 158, 164, 169
 Examples, 6, 24, 28, 34, 37, 39, 41, 43, 44, 46, 47, 87, 88, 90, 107, 124, 126, 148, 154
 External Drives, 169

 Feet, 57, 58, 97, 106, 111, 174
 File, 2, 5, 79, 84, 100, 101, 108, 131, 132, 133, 138, 154, 169
 Final Drive Ratio, 27, 60, 65, 114, 117, 120
 Finish, 1, 56, 62, 75, 76
 Finish Engine RPM, 76
 Finish MPH, 75, 76
 Finish Trans Gear #, 76
 Flywheel, 16, 150, 151, 152
 Front Wheel Drive, 28, 34, 35
 Front Wheel/Tire, 34, 126, 151
 Frontal Area, 31, 67, 89, 152, 153
 Frt Roll Stfns, 28, 30, 31
 Full Power Curve, 14, 15, 16, 18, 62

 Gear Ratio, 25
 Graph, 5, 1, 6, 8, 14, 18, 43, 44, 46, 47, 95, 96, 97, 98, 111, 112, 113, 116, 118, 169, 173, 174, 176, 177, 178, 179, 180, 181
 Graph Back Color, 181
 Graph cursor, 176, 177
 Graph Grid Style, 181
 Graphxe "Graphs" Labels, 96
 Graph Legend, 176, 178
 Graphxe "Graphs" with Baseline, 98
 Graphxe "Graphs" without Baseline, 98
 Graph, Cursor, 176, 177
 Graph, Edit Printed Comments, 181
 Graph, Grid Style, 169, 181
 Graph, Line Style, 180, 181
 Graphs, 96, 98
 Grid Style, Graph, 169, 181

 Height of CG, 29, 145, 152

History, 5, 1, 54, 105, 106, 108, 114, 115, 116, 117, 118, 155, 169, 174, 175
Humidity, 1, 5, 17, 18, 51, 52, 71, 72, 73, 106, 123
Improvement, 7, 56, 106
Improvement Summary, 56
Imprvmnt, 106
Include Vehicle Comments, 104
Include Vehicle Specs, 103
Index, 6, 77, 80, 81, 86, 138, 140, 142, 145, 158, 189
Index, sec, 81
Inertia, 13, 16, 34, 47, 149, 150, 151, 152
Install, 4, 70, 154, 176
Know Dew Point?, 72
Know Relative Humidity?, 71
Last Run, 56
Launch, 38, 39, 40, 41, 42, 43, 44, 45, 46, 47, 59, 75, 111, 113, 116, 117, 127, 147, 148
Launch % Clutch, 40, 41, 44
Launch % Throttle, 40, 41, 44, 46, 59
Launch RPM, 39, 40, 42, 43, 44, 117, 148
Launch Time, 40, 41, 43, 44, 45, 46, 47
Legend, graph, 176, 178
Let Program Estimate Clutch Specs, 22, 23, 74
Letter Tire Size, 69
Line Style, Graph, 180, 181
Load from Eng. Anlzd., 18, 19
Main Menu, 4, 5, 6, 9, 11, 13, 19, 37, 49, 56, 70, 74, 77, 82, 100, 108, 109, 113, 114, 119, 121, 123, 125, 127, 129, 130, 132, 138
Match Vehicle Performance, 5, 1, 17, 37, 70, 74, 75, 119, 129, 130, 131
Method of Describing Power Curve, 16, 17, 121
Method of Recording Weather Data, 50, 71, 72, 80, 85, 120, 140
Metric Tire Size, 69
Motorcycle, 28, 31, 32, 35
MPH, 1, 7, 23, 45, 53, 56, 57, 58, 61, 62, 75, 77, 82, 97, 106, 108, 111, 114, 119, 120, 121, 123, 125, 127, 129, 132, 134, 138, 141, 143, 148, 149, 151, 155, 164, 174
Open, 1, 5, 23, 32, 79, 84, 99, 100, 108, 119, 132, 138, 155
Optimum, 1, 33, 42, 117, 127, 143, 149
Outside Air Temp, 71, 72
Outside Rel Humidity, 71
Peak Horsepower, 16, 17, 60, 61, 62, 121, 129
Peak HP Only, 16, 17
Peak Torque, 16, 17, 61, 62
Peak Torque and HP Only, 16
PERFTRNS.PTI, 102, 108
Pick An Example, 88
Plot Lines, 97
Preferences, 5, 13, 56, 57, 77, 82, 108, 119, 132, 137, 142, 146, 164
Print, 5, 1, 2, 8, 18, 91, 97, 98, 103, 104, 154, 164, 169, 176, 178
Print Now, 97
Prvs Run Always Changes to Baseline, 98
Quarter Mile MPH, 61, 63, 121, 143
Radius, 36, 37, 69
Rating Type (Tire), 68
Rear Axle Ratio, 27, 60, 65, 113, 114, 117, 120
Rear Track Width, 28, 30, 67, 126
Recycle Bin, 169
Registered Owner, 3, 4
Relative Humidity, 1, 50, 51, 71, 72, 79, 84, 123, 134, 140, 141
Remind on Tire Wt Change, 13
Request Report Comment, 104
Rolling Radius, 35, 36, 68, 69
Rollout, 43, 44, 47, 54, 56, 57, 109, 123
Roof Height, 67
RPM at Peak HP, 17, 61
RPM at Peak Torque, 17, 61, 62
Safety, 4, 3, 8, 27, 29, 81, 82, 86, 91, 93, 134, 135, 140, 142, 155, 158
Save, 1, 5, 19, 79, 84, 90, 100, 131
Save As, 79, 84

Sec Increments, 13, 108, 118, 119, 132, 137, 142, 146
 Select Current Run as Baseline, 98
 Setup, 4, 70, 154, 176
 Shift, 1, 17, 41, 42, 43, 44, 45, 46, 47, 57, 61, 64, 109, 116, 117, 120, 122, 127, 131, 147, 148, 149, 169
 Shift % Throttle, 41, 42, 44, 59, 117, 149
 Shift RPM, 17, 41, 42, 44, 46, 64, 70, 109, 120, 127, 149, 169
 Shift RPMs, 17, 41, 42, 44, 46, 64, 70, 109, 120, 127, 149, 169
 Shift Time, 41, 42, 44, 47, 117, 127, 147, 148, 149
 Slicks, 36, 37, 117, 120, 126
 Stall RPM, 1, 23, 40, 45, 46, 75, 120, 124, 148
 Stall RPM at Launch, 75
 Suspension, 26, 27, 28, 30, 31, 36, 70, 145

 T Slip, 58
 T/S Start Time, 81, 140
Tech Help, 3
 Thick Lines, 14
 Thin Lines, 14
 Throttle Stop, 5, 6, 1, 52, 71, 72, 77, 78, 79, 80, 81, 138, 139, 140, 141, 142, 154, 155, 158, 159
 Throttle Stop Prediction, 5, 77, 142, 155, 159
 Tire Diameter, 35, 36, 60, 68, 69, 74, 76, 117, 120, 164
 Tire Growth, 36, 37, 74, 147, 148
 Torque Converter lock up, 27, 169
 Total Vehicle Weight, 29, 66
 TqMult, 58
 Track Length, 53, 56
 Track Weather, 50, 124, 138
 Traction, 2, 27, 29, 30, 31, 33, 36, 37, 39, 70, 74, 80, 82, 85, 111, 116, 118, 120, 136, 143, 147, 148, 151
 Traction Factor, 2, 36, 37, 70, 74, 120, 147, 148
 Trans Brake, 23, 45, 75, 77, 140
 Transmission, 5, 1, 6, 16, 21, 22, 23, 24, 25, 27, 28, 39, 40, 41, 43, 44, 45, 46, 47, 57, 65, 66, 75, 76, 90, 103, 120, 124, 125, 147, 148, 149, 150, 152, 154, 164, 169, 174
 Trap Speed, 7, 53, 56, 111
 Tread, 35, 36, 68, 69, 117, 120, 164
 Tread Width, 36, 68, 117, 120, 164

 Vehicle Library, 5, 6, 9, 91, 99, 100, 110, 119, 131, 132, 138, 147
 Vehicle Weight, 26, 60, 61, 63, 66, 120, 121, 122, 143, 151, 152, 153
 Version 3, 6, 1, 104, 132, 135, 138, 142, 154, 158, 164, 169
 Vol Eff, 61, 62, 63, 121

 Weather, 1, 9, 17, 23, 50, 51, 52, 71, 73, 77, 79, 80, 82, 84, 104, 106, 109, 119, 121, 122, 132, 134, 136, 137, 138, 140, 141, 142, 158, 159, 174
Weather Stations, 50, 52
 Weight on 1 Axle, 67, 125
 Wet Bulb, 71, 72, 73, 121
 Wheel Rim Diameter, 69
 Wheel/Tire, 34, 35, 70, 117, 126, 127
 Wheelbase, 30, 120, 126
 Wheels & Tires Wt, 35
 Which Axle?, 67
 Wind, 53, 121, 123, 134, 140, 145
 Wind Direction, 53, 121, 145
 Wind Speed, 53, 121, 123, 145
 Windows, 1, 2, 18, 19, 20, 32, 102, 108, 154, 164, 176

 Zoom, 169